

UPDATE IN ANAESTHESIA



A journal for anaesthetists in developing countries

WORLD ANAESTHESIA

No. 13 2001

ISSN 1353-4882

EDITORIAL

We regularly receive letters asking for back numbers of Update. Unfortunately we only print as many copies of Update as we need for our mailing list and therefore do not have supplies of previous editions. However it is clear from your feedback that many readers would appreciate some of the previous editions of Update in the form of a small book. This is a project which World Anaesthesia are looking into, and if the necessary sponsorship can be obtained, we shall print a collection of back numbers early next year.

For the moment, however all previous editions of Update and the Primary Trauma Care Manual are available on a computer CD Rom (email Michael.Dobson@nda.ox.ac.uk) and on the web at www.nda.ox.ac.uk/wfsa. The first French edition of Update was published recently and is available on the web at www.sfar.org/update/updatechapo.html. Contact addresses for the different version of Update are printed below.

The demand for Update continues to increase both for the printed and electronic version. We hope that it continues to be of interest. Please send any ideas for articles or topics to the editor, using the address on the back page. We are looking forward to meeting many of our readers and contributors at the All Africa Anaesthesia Congress in Durban 23-6 September 2001. Details about this conference are on page 63.

Dr Iain Wilson

Editor - Update in Anaesthesia

Contents: No. 13

Medical Grade Compressed Air	2
Delayed Awakening from Anaesthesia	4
Extracts from the Journals	7
Using the Hemocue	9
Basic Pharmacology I	11
Post Herpetic Neuralgia	13
The Management of Sepsis	16
Anaesthesia Self Evaluation	26
Epidural Anaesthesia	39
Acid Base Balance	52
Letters to the Editor	62
Book Review	63

Contacts

Russian Edition:- Andrei Varvinski, Dept. of Anaesthesia, University of Wales School of Medicine, Heath Park, Cardiff, U.K.

Email: avarvinski@hotmail.com

Spanish Edition:- Oscar Gonzales, Rio Parana 445, Bo Felicidad - Lambare, Paraguay

Email: ojgam@conexion.com.py

French Edition:- Michel Pinaud, Service d'anaesthesia, Hotel Dieu, 44093 Nantes Cedex 1, France

Email: michel.pinaud@chu-nantes.fr

Website: www.sfar.org/update/updatechapo.html

Mandarin Edition:- Jing Zhao, Dept. of Anaesthesia, Peking Union Medical College Hospital, No. 1 Shuai Fu Yuan, Beijing 100730, Peoples Rep. of China

MEDICAL GRADE COMPRESSED AIR

Professor Rebecca Jacob M.D.,D.A., Kumaresh V. D.A. Senior Registrar, Department of Anaesthesia
Christian Medical College Hospital, Vellore, India

Compressed air is required in hospitals to operate surgical instruments such as pneumatic drills and saws. Air is also used to run ventilators and may be used as a carrier gas in anaesthesia. Although oxygen may also be used it is very expensive. In small hospitals oxygen concentrators with air compressors are used which are capable of driving ventilators. The amount of compressed air produced is however insufficient for use in larger hospitals.

In our hospital we decided to produce our own supplies of compressed air. Initially we bought cheap, commercially available oil lubricated compressors. There were no dryers (or dessicators) incorporated and mild steel pipelines were used to transport the compressed air to the operating rooms. Contamination of the air unfortunately occurred very rapidly with oil and dust, along with rust from the mild steel pipelines, and caused frequent problems. The ventilators got clogged, needed frequent cleaning and servicing, the drills seized and neonatal ventilators failed.

Specification of medical air

Medical grade air should be free from toxic products, flammable or toxic vapours, and odours at all points in the pipeline system. Although it is not sterile medical grade air is clean and at STP (standard temperature and pressure) should not contain more than:

- 0.5mg of particulate oil mist /cubic metre of air
- 5.5mg of carbon monoxide/ cubic metre of air
- 900 mg carbon dioxide/ cubic metre of air
- no moisture
- no bacterial contamination

Surgical instruments require compressed air at 7.2bar or 105psi

Anaesthetic ventilators require compressed air at 4.1 bar or 60psi

Components of compressed air system

The system consists of various parts which include the air inlet, compressors, reservoirs, dryers or dessicators, coolers, filters, conduits and pipelines.

Air inlets (air intake) for a compressor producing medical grade air should be located in such a way that

it will minimise contamination from internal combustion engines' exhausts, discharge from hospital vacuum pumps and other sources of contamination. They should ideally be located outdoors and protected from rain, dust and fumes. This is not easy in the centre of a city with heavy vehicular traffic. Therefore if the quality of air is unreliable it is better to filter the air at the inlet. Filters may be dry medium filters or paper element filters. More than one may be required. These filters may add to the initial expense but this is small compared to the greater costs which will be incurred by the use of unfiltered air.

Air compressors are of different types. Ideally two or more compressors should be available. Each one must be capable of handling 100% of the estimated peak flow demand. Oil lubricated compressors are cheaper but it is very difficult to filter out the oil mist which may be produced. Oil free compressors are best, but it must be remembered that they are oil free only as long as the seals to their oil lubricated parts remain effective. The material from which the sealing rings are made is also important. Carbon releases carbon monoxide and carbon dioxide on overheating, PTFE releases toxic gases on overheating. Water sealing is not suitable if the water is hard or contains solids in suspension.

Air pressure in the compressor air receiver acts as a reservoir and should always be higher than that required for instruments and should allow for pressure loss occurring downstream in pipelines, dryers and filters. Pressure regulators should always be downstream from the dryers.

Aftercoolers During compression air gets heated and cools during its transit and delivery to the operating rooms. It is during this time that condensation occurs leading to the corrosion of mild steel pipelines which results in malfunction of equipment. Compressed atmospheric air contains water vapour which may be removed by a cooling process. This may be done by air, water, or a refrigeration medium. This process must be efficient to keep the subsequent condensation to the minimum. The humidity should be such that the dew point of air supplied is < 40°C. (Dew point is the temperature at which condensation occurs when a gas mixture cools).

The Air Receiver acts as a reservoir for the compressed air. It maintains a constant pressure and ensures that an uninterrupted non-pulsatile air flow is delivered. Ideally each compressor should have its own reservoir or receiver. Air receivers should be supplied with test certificates stating that they can withstand twice the normal working pressure. Air receivers should be fitted with automatic drain traps with valves which allow condensed water to drain away to an outside drain. Each receiver should also be fitted with safety valves, a pressure gauge and an inspection window to check that the drain is working. They should also be fitted with non return and isolation valves. The receiver must be provided with a bypass to permit servicing without shutting down the piped air system.

Dryers and dessicators may be of two types - the refrigerator type or the heatless dessicant type. The dessicants may be silica gel, activated alumina or a molecular seive. They should be two to a unit and the change over from one to the other when the first one is exhausted should be automatic.

The separator trap and filter assembly is required to finally filter out the residual water, oil mist or droplets and other particulate matter. It should have a trap with an automatic or manual drain and a manual bypass. Ideally this bypass should lead to an alternate filter. Filters should have an efficiency of not less than 95% and a filter penetration of 0.5%. These filters are very expensive.

Pipelines should be of copper and not mild steel which is prone to rust.

It is sensible to have a 'testing' outlet from the compressed air pipeline just prior to its entering the operating room complex so that a quality check may be made of the air.

It is always preferable to have a duplex system with interconnecting compressors, air receivers and dryers of similar capacity connected by a bypass or isolation valves which allows the servicing of a compressor, air receiver or dryer at any time whilst ensuring an uninterrupted supply of compressed air.

Audiovisual alarm systems are an option which may be used to monitor the line pressure. They may be fitted at vantage points such as nursing stations etc.

Although initially expensive, with proper care and maintenance, a relatively simple set up will provide supplies of medical grade compressed air for the running of surgical instruments and ventilators for many years.

References

1. Conely JIM, Railton R, Mackenzie AI. Ventilator problems caused by humidity in the air supplied from simple compressors. *British Journal of Anaesthesia*. 1981;53;549
2. Dorsch JA. Understanding anaesthesia equipment. Publisher. Williams and Wilkins 3rd ed.. Pages 29-30
3. Parbrook GD, Davis PD, Kenny GNC. Basic physics and measurement in anaesthesia Publisher. Butterworth Heinemann 4th Ed. 1995. Pages 146-9 and 273-4
4. Mushin WW. Physics for the anaesthetist. Publisher. Blackwell Scientific Publications, 2nd Ed. Pages 73-5

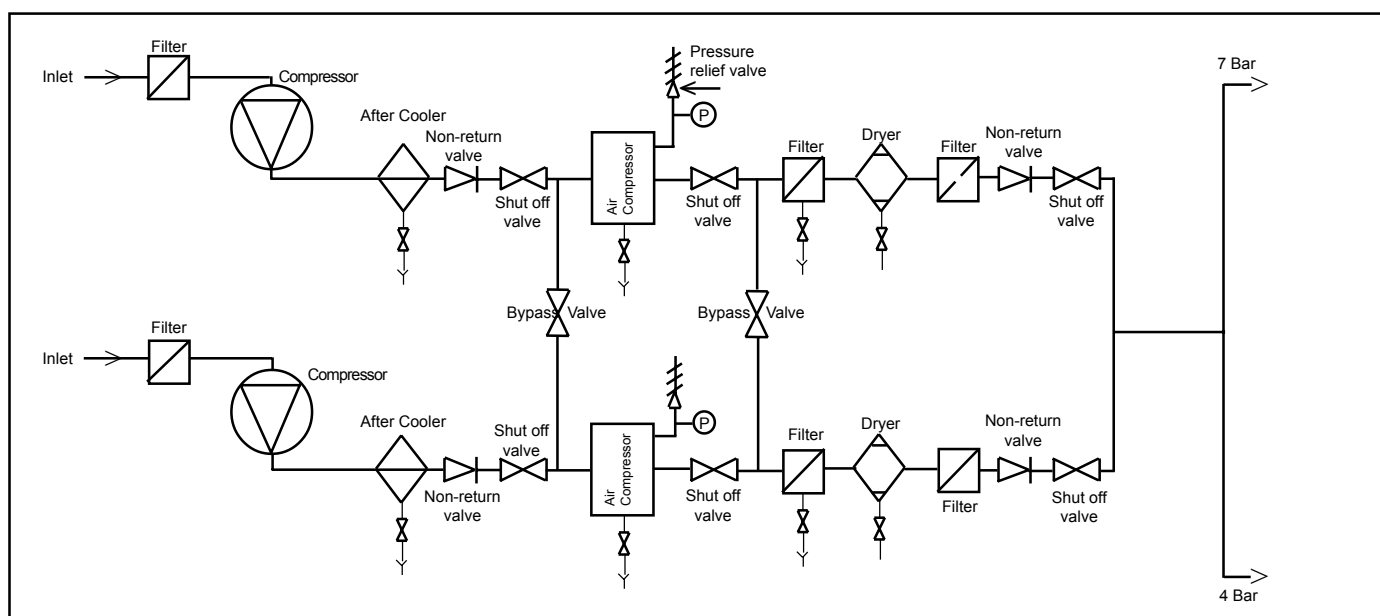

DELAYED AWAKENING OR EMERGENCE FROM ANAESTHESIA

Jyothi Radhakrishnan, Sujatha Jesudasan, Rebecca Jacob, Vellore, India

At the end of anaesthesia and surgery the patient should be awake or easily rousable, protecting their airway, maintaining adequate ventilation and with their pain under control. Time to emerge from anaesthesia is very variable and depends on many factors related to the patient, the type of anaesthetic given and the length of surgery.

CAUSES OF DELAYED AWAKENING

Residual Drug Effects

- **Overdose.** Too much drug may have been given or the patient is unduly susceptible. Frail, small or elderly patients generally require lower doses than fit, normally sized adults. Delayed drug metabolism occurs in renal or hepatic failure, and smaller doses may be required. In certain conditions there may be increased sensitivity to particular agents. For example there is greatly increased sensitivity to non-depolarising muscle relaxants in myasthenia gravis.

- **Duration and type of anaesthetic given.** For inhalational anaesthetic agents the speed of emergence is directly related to alveolar ventilation. Therefore hypoventilation is a frequent cause of delayed emergence. Speed of emergence is also inversely related to the blood gas solubility of the agent, so the less soluble agents eg: nitrous oxide and halothane are eliminated more rapidly than ether. When the duration of anaesthesia is prolonged, emergence also depends on the total tissue uptake of the drug which is related to drug solubility, average concentration used and the duration of exposure.

For intravenous anaesthetic agents, immediate recovery depends mainly on redistribution from blood and brain into muscle and fat. Patients given propofol for induction and /or maintenance recover faster than those receiving other agents because propofol is rapidly metabolised by the liver and possibly also at other extrahepatic sites. Elimination half life is relatively fast (10 to 70 minutes), and it does not accumulate.

With thiopentone however, whilst the initial drug effect is terminated by redistribution within 5 to 15 minutes. Elimination is by oxidative metabolism in the liver

at a rate of 15% per hour. It therefore has a long elimination half life of 3.4 to 22 hours and as much as 30% of the dose may remain in the body at 24 hours. Cumulative effects may therefore become apparent when more than one dose is given. For most other intravenous anaesthetic drugs the termination of drug action depends on the time required to metabolise or excrete the drug (elimination or metabolic half life) and in this situation, advanced age or renal or hepatic disease can prolong drug action.

- **Potentiation by other drugs.** Prior ingestion of sedative premedication such as benzodiazepines, or alcohol, will potentiate the central nervous system depressant effects of anaesthetic and analgesic drugs, and may delay emergence from anaesthesia.

- **Prolonged neuromuscular blockade.** Residual neuromuscular blockade results in paralysis which may be perceived as unresponsiveness though the patient may be fully conscious and aware. This may occur secondary to overdose or incomplete reversal of non-depolarising muscle relaxants or in a patient with suxamethonium apnoea. A nerve stimulator will assist the diagnosis. Alternatively inability to maintain head lift for 5 seconds in a patient who could normally comply with this request indicates residual block of greater than 30% of receptors. The typical twitchy movements of partial reversal may also be seen, and the patient may become distressed and agitated.

Prolonged apnoea following suxamethonium “scoline apnoea” is due to an abnormal or absent plasma cholinesterase enzyme. In pregnancy and liver disease, levels of this enzyme also tend to be lower and suxamethonium may produce longer lasting muscle relaxation. Repeated doses of suxamethonium (>6-8mg/kg total dose) may produce a “dual block” which is prolonged and slow to recover. The newer muscle relaxant mivacurium is also metabolised by plasma cholinesterase and ‘mivacurium apnoea’ may occur rarely.

Patients with myasthenia gravis are very sensitive to non-depolarising muscle relaxants, doses of only 10 to 50% of the usual dose are required and long acting agents like pancuronium should be avoided. In the

PRACTICE POINT - Relaxants

- Avoid excessive doses of relaxants.
- Intermediate acting drugs such as atracurium or vecuronium are easier to use than long acting ones.
- Only give repeat doses when necessary (when there is evidence of muscle activity).
- When giving repeat doses use 20-25% of the initial dose.
- Wherever possible use a nerve stimulator to guide doses and assess reversal.

muscular dystrophies there is also increased sensitivity to muscle relaxants and to all respiratory depressant drugs.

In renal failure there is reduced elimination of non depolarizing muscle relaxants such as pancuronium and vecuronium. Large doses of aminoglycoside antibiotics (gentamicin etc) can prolong muscle relaxant action. Acidosis can also have this effect.

Respiratory Failure

Patients who do not breathe effectively during or after anaesthesia may become hypercarbic (raised CO₂) to a level that may produce sedation or even unconsciousness. Risk factors include underlying respiratory disease, particularly those with CO₂ retention preoperatively, high dose opioids, obstructed airway and poor relaxant reversal. The diagnosis is usually suspected clinically and may be confirmed by arterial blood gas analysis or measurement of the end tidal CO₂. Note that patients receiving oxygen may have normal SpO₂ readings even with significantly raised CO₂ readings.

Metabolic Derangements

An underlying metabolic disorder may be responsible for delayed recovery after anaesthesia. Conditions include:

- **Hypoglycemia.** Can occur in small children and those who have been given insulin or oral hypoglycaemic drugs. It may also occur in liver failure, in the presence of alcohol excess and in septicemia and malaria.

- **Severe hyperglycemia.** May occur in decompensated diabetics ie: hyperosmotic hyperglycaemic diabetic coma, or diabetic ketoacidosis.

- **Electrolyte imbalance.** This may be secondary to the underlying illness or as a consequence of the surgical procedure e.g. hyponatraemia occurring with trans-urethral resection of prostate (where glycine or other hypotonic fluid is used for irrigation).

- **Hypothermia.** Severe hypothermia may lead to reduced conscious level. A core temperature of less than 33°C has a marked anaesthetic effect itself and will potentiate the CNS depressant effects of anaesthetic drugs. In addition hypothermia reduces the MAC value of inhalational agents, antagonises muscle relaxant reversal and limits drug metabolism.

- **Central anticholinergic syndrome** may rarely follow the use of anticholinergic drugs especially hyoscine, but also antihistamines, antidepressants, phenothiazines and pethidine. It has also been reported after volatile anaesthetic agents, ketamine and benzodiazepines. Thought to be due to a decrease in inhibitory anticholinergic activity in the brain, it may be manifest as confusion, restlessness, hallucinations, convulsions and coma, and therefore as delayed awakening from anaesthesia. Peripheral anticholinergic effects; dry mouth, tachycardia, blurred vision etc may also be present. Treatment is with physostigmine 0.04mg/kg slowly iv which acts within 5 minutes, but features may return after 1-2 hours.

Neurological Complications

- **Cerebral hypoxia** of any cause will result in reduced conscious level which may first present as delayed awakening from anaesthesia, especially if the hypoxic insult has occurred during anaesthesia.

- **Intracerebral event** such as haemorrhage, embolism or thrombosis. This is very rare except in neurosurgery, cardiac surgery, cerebrovascular and carotid surgery.

EVALUATION AND MANAGEMENT**Immediate care**

- **Airway** - maintain a clear airway and give oxygen. Reintubate if indicated.

- **Breathing** - ensure adequate respiration. If indicated ventilate the patient effectively via an endotracheal tube. Monitor SpO₂.

- **Circulation** - assess blood pressure, heart rate, ECG, peripheral perfusion, conscious level and urine output. Resuscitate as indicated.
- **Review** the history, investigations, and perioperative management, including the anaesthetic chart and the timings of drug administration, looking for a possible cause of the delay in recovery.
- **Assess for persisting neuromuscular blockade**, using a nerve stimulator if available. Alternatively if the patient is awake enough to obey commands ask them to lift their head off the pillow for 5 seconds. If the patient is still paralysed they should be sedated or kept anaesthetised, and ventilated until the block is fully reversed. A further dose of reversal agent eg; neostigmine 2.5mg plus glycopyrrolate 0.5mg or atropine 1mg may be tried. Where there is prolonged neuromuscular block in suxamethonium apnoea, prolonged ventilation (up to 12 - 36 hours) may be required.
- **Look for signs of opioid narcosis** - pin point pupils and slow respiratory rate. In this situation a test dose of naloxone may be given: iv increments of 100 to 200 micrograms are usually sufficient. (child = 10 micrograms/kg, subsequent dose of 100 micrograms/kg if no response.). If too much is given the analgesic effect of the opioid will be antagonised and the patient will be in pain. The dose should therefore be titrated to effect. The duration of action of naloxone is approximately 20 minutes and this may be shorter than the effect of the opioid. Subsequent doses of naloxone may therefore be required, and these may be given intramuscularly, or a naloxone infusion may be required (800 micrograms in 500 mls of normal saline over 6 hours).
- Where it is suspected that the delayed recovery is due to an excess of **benzodiazepine** (diazepam or midazolam) or other drugs, management is supportive, with maintenance of airway and ventilation until the drug has been metabolised. Where the specific

benzodiazepine antagonist flumazenil is available it can be tried (iv increments of 0.1mg to a maximum adult dose of 1mg). However, Flumazenil is expensive, and may cause arrhythmias, hypertension and convulsions. It's use is generally not indicated.

- **Measure the patient's temperature**, and warm if necessary. Forced air warming with a Bair hugger or similar device is the most effective method. However wrapping in blankets, and / or tin foil sheets, ensuring the room is kept warm, and giving warmed iv fluids, will also help.
- **Check blood glucose** - and correct with iv dextrose if it is less than 3mmol/l. Hyperglycaemia should be managed as described in Update in Anaesthesia No 11.
- **Measure and correct plasma electrolytes** - hyponatraemia should be corrected slowly, as there is a risk of subdural haemorrhage, central pontine myelinolysis and cardiac failure if correction is too rapid. The optimal rate is uncertain, but a maximum safe rate of 5 -10 mmol/l/day has been suggested, or up to 2mmol/l/hour until the plasma sodium is 120 mmol/l.
- If no other cause can be found for delayed emergence from anaesthesia, an intracerebral event may be suspected and a full neurological examination should be performed, looking particularly for localising signs. However radiological imaging (CT or MRI scan) is often required to confirm the diagnosis.

Summary

Delayed awakening of varying degrees is not uncommon after anaesthesia, and may have a number of different causes, individual or combined, which may be both drug or non - drug related. The primary management is always support of airway, breathing and circulation, whilst the cause is sought and treated as outlined above.

EXTRACTS FROM THE JOURNALS

Dr Henk Haisma, University Hospital Groningen, POBox 30001, 9700 RB Groningen, the Netherlands, e-mail H.J.Haisma@anest.azg.nl

Anticoagulants and spinal or epidural anaesthesia

Drug induced impairment of coagulation may have detrimental effects in the patient receiving central neural blockade. Vertebral canal haematoma is a catastrophic complication, more often associated with epidural catheter use than with any other central nerve block technique. Horlocker and Wedel^[1] calculated the risk of spinal haematoma and found a significantly increased incidence in the presence of anticoagulants. Other risk factors included technically difficult punctures sometimes due to anatomical abnormalities of the spinal cord and multiple or bloody punctures.

It is important to notice, that the initial complaint of a patient with a spinal haematoma is not severe radicular pain, but weakness outlasting the anticipated duration of the motor blockade or a new onset of lower limb weakness or numbness. Neurosurgical intervention must be sought immediately because recovery is unlikely if surgery is postponed more than 8h.

To reduce morbidity and mortality due to postoperative thromboembolic complications, patients receive thromboprophylaxis. The safety of major neuraxial anaesthesia in the presence of thromboprophylactic subcutaneous doses of unfractionated heparin was documented by several authors and supported by the fact that until 1996 only five incidences of spinal haematoma had been reported. However, since the beginning of 1990, when low molecular weight heparins (LMWH) were introduced for thromboprophylaxis, there has been an increase in the incidence of spinal haematoma, especially in the USA.

LMWH are highly effective agents which are administered subcutaneously, don't need laboratory monitoring of the anticoagulant response, nor dose adjustment for weight (although therefore a relative overdose could occur in smaller patients). The biological half-life of a LMWH is 4-7 hours, 2-4 times that of standard heparin and LMWH have a low affinity for plasma protein resulting in a greater bioavailability. The current recommended thrombo-prophylactic dose in the USA is 30 mg enoxaparin twice daily, implying with this long half life, no relative safe time for performing a block or removing the catheter. In the

USA nearly 40 cases of spinal haematoma have been recorded and a FDA Health Advisory was issued in December 1997. Horlocker and Wedel made the following recommendations in an editorial in *Anesthesia and Analgesia*^[2]:

- 1) The smallest effective dose of LMWH should be administered. The FDA has recently approved enoxaparin 40 mg once daily, which is in line with European dose schedule.^[3]
- 2) LMWH therapy should be delayed as long as possible with a minimum of 12h and ideally 24 h postoperatively. Again here is a difference with Europe, where patients get their starting dose 12h before surgery. In the USA patients undergo even major surgery on the day of admission. This means that it is not possible to give them the first dose of LMWH 12 h before surgery.
- 3) Antiplatelet or oral anticoagulant medications should not be given in combination with LMWH because the combination will increase the risk of spinal haematoma.
- 4) Catheter removal should occur when anticoagulation activity is low, so more than 12h after LMWH administration and more than 4 h before the next dose.

Spinal or epidural anaesthesia before intraoperative systemic heparinization has been shown to be relatively safe when a minimum interval time of 60 minutes is observed between the initiation of the block and subsequent heparinization. The removal of the indwelling catheter is performed only after the complete disappearance of remaining heparin effect.

In general, patients treated with platelet aggregation-inhibiting drugs are no longer seen as problematic in central nervous blockade. However when combined with a form of heparin therapy central nervous blockade should not be performed.

1. Horlocker TT, Wedel DJ. Neuraxial block and low-molecular weight heparin: balancing perioperative analgesia and thromboprophylaxis. *Regional Anesthesia Pain Medicine* 1998;23(suppl2):164-177

2. Horlocker TT, Wedel DJ. Spinal and epidural blockade and perioperative low molecular weight heparin: smooth sailing on the Titanic (editorial). *Anesthesia Analgesia* 1998;86:1153-1156

3. Checketts MR, Wildsmith JAW. Editorial II. Central nerve block and thromboprophylaxis-is there a problem? *British Journal Anaesthesia* 1999;82:164-167

Postoperative shivering

Most patients have lower postoperative core temperatures than preoperative values, especially those who are not actively warmed during their surgical procedure. Anaesthetic agents lower the threshold for shivering by 2-4°C and therefore unwarmed surgical patients usually become hypothermic. Shivering doesn't occur during surgery but, in an attempt to increase temperature, appears postoperatively when the plasma concentration of the anaesthetic agents decreases. The threshold for vasoconstriction is approximately 1°C above the threshold for shivering, hence vasoconstriction precedes shivering. Clinical observations suggest, that shivering is also common during spinal and epidural anaesthesia.

Postoperative shivering may also occur when the core temperature is normal, but the patients thermoregulatory setpoint is increased by fever or by the release of cytokines secondary to activation by surgery. Shivering increases the oxygen demand and can be dangerous, especially in cardiac compromised patients.

Horn et al ^[1] demonstrated that nonthermoregulatory shivering exists i.e. tremor in patients who were normothermic and had no fever. Electromyographic analysis indicates that tremor, in patients who are normothermic and recovering from isoflurane anaesthesia, differs markedly from the normal 4-8 cycle/min pattern of thermoregulatory shivering. They studied 120 patients undergoing major elective orthopaedic operation. Patients were selected randomly to maintenance anaesthesia with isoflurane

or desflurane and, on a 1:1 basis, allowed to become hypothermic, whereas normal temperature was maintained in the others. Active warming started just before anaesthesia was induced and was discontinued at the end of the operation. Postanaesthetic shivering was graded by a blinded investigator using a four-point scale. Approximately 50% of the unwarmed patients shivered; 27% of the normothermic patients shivered. The overall incidence of shivering was comparable in the isoflurane and desflurane group which is consistent with previous studies suggesting that the thermoregulatory effects of various volatile anaesthetics are similar.

Numerous drugs have proven effective for the treatment of post-anaesthetic shivering. Grundmann et al ^[2] studied the effects of pethidine (0.3mg/Kg) and clonidine (2mcg/Kg). Their results were in favour of clonidine (5% shivering) compared with pethidine (25%) and placebo (55%). Heart rate and blood pressure values were lower after the administration of clonidine than after pethidine, and significantly lower than after saline. The time between end of surgery and extubation was similar in all groups with an average of 18 minutes. There were no significant differences in the pain scores among any of the groups. Clonidine has peripheral and central effects resulting in lowering bloodpressure, light sedation and some analgesic effect. The effect of clonidine on postanaesthetic shivering is probably due to resetting the threshold for shivering.

1. Horn EP, Sessler DI, Standl T, Schroeder F, Bartz HJ, Beyer JC, Schulte am Esch J. Non-thermoregulatory shivering in patients recovering from isoflurane or desflurane anaesthesia. *Anesthesiology* 1998;89:878-886

2. Grundmann U, Berg K, Stamminger U, Juckenhofel S, Wilhelm W. Vergleichende Untersuchung von Pethidin und Clonidin zur Prophylaxe des postoperativen Kaltezitterns. *Anesthesiol Intensivmed Notfallmed Schmerzther* 1997;32:36-42

THE HEMOCUE B-HAEMOGLOBIN ANALYSER

Mathieu Ickeringill, Royal United Hospital, Bath

The HemoCue B-Haemoglobin analyser is a portable, rapid and accurate method of measuring haemoglobin at the bedside. It is particularly useful in acute clinical situations and as a guide for blood transfusion requirements. It is easily used by any healthcare workers after a short period of training.

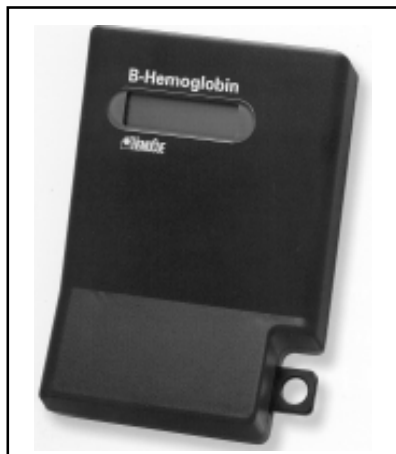

How it works

The HemoCue system consists of disposable **microcuvettes**, which contain reagents (chemicals) in dried form. Blood is placed in the microcuvettes and a portable photometer (light measuring instrument) determines the Hb. The **photometer** operates from an AC adaptor or five 1.5V dry cell batteries.

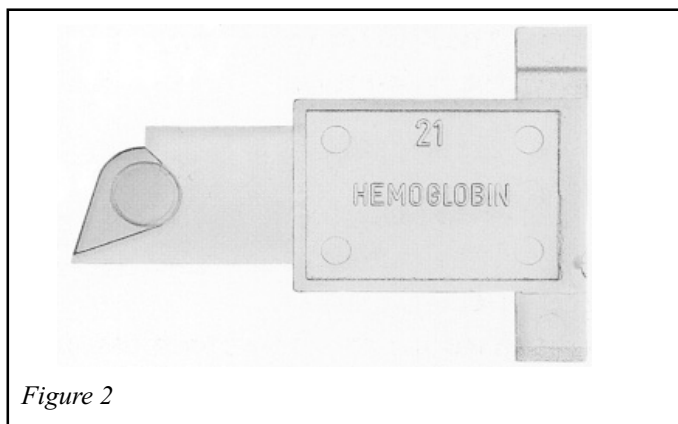
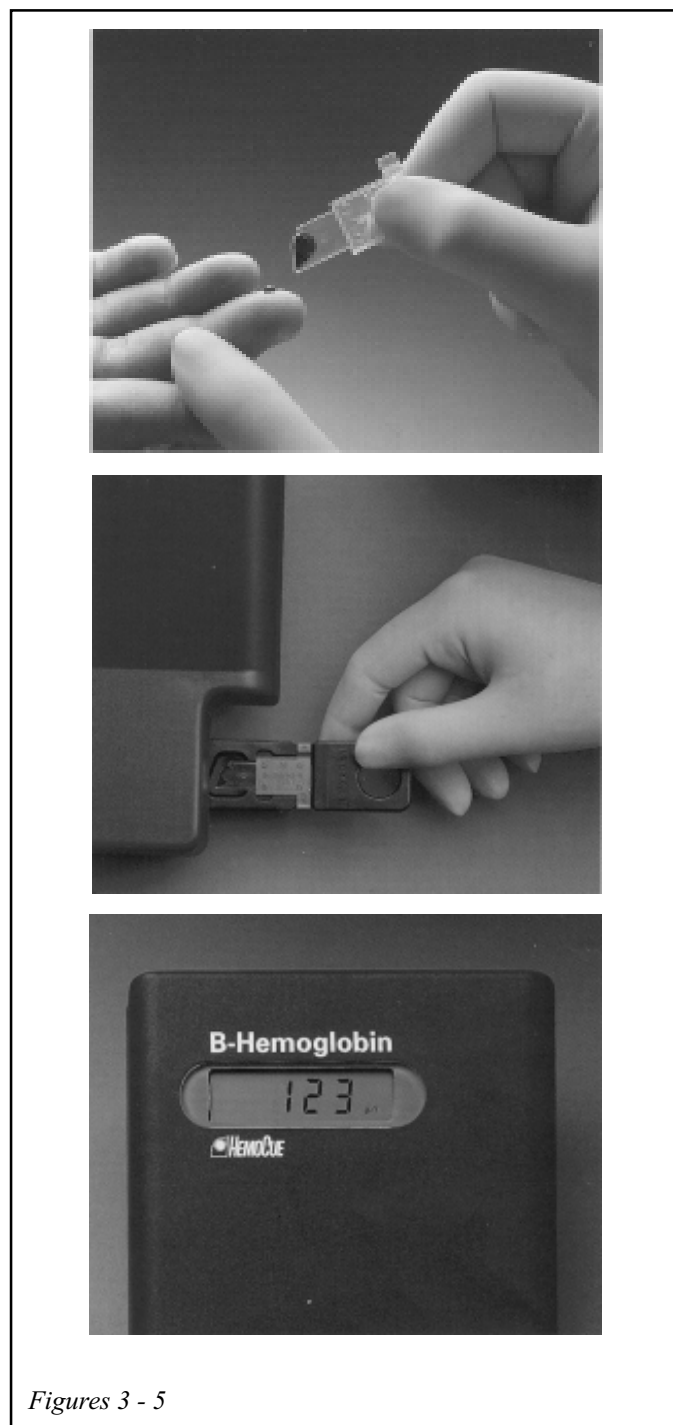

Figure 2

Each microcuvette has a volume of 10 μ l and a short light path of 0.13nm between the parallel walls of the clear optical windows. The microcuvette contains 3 reagents in dried form which convert the Hb into methaemoglobinazide (HiN3).

- Sodium deoxycholate haemolyses the red cells
- Sodium nitrite converts Hb (ferrous;Hb) to methaemoglobin (ferric;Hi)
- Sodium azide converts methaemoglobin (Hi) to methaemoglobinazide (HiN3)

Whole blood is drawn up into the microcuvette by capillary action and inserted into the HemoCue photometer. Light is passed through the sample and the absorbance of methaemoglobinazide is measured at 570nm and 880nm to ensure automatic compensation for turbidity (due to lipaemia or leucocytosis). Results are then displayed after 45 to 60 seconds in g/dl on an LCD display.



Figures 3 - 5

After each measurement the photometer automatically zeroes itself, and checks the intensity of the light source and the operation of the photocell. A control microcuvette is supplied with each photometer to allow verification of calibration of the photometer.

How to use a HemoCue

The microcuvettes are supplied in tubs with airtight lids designed to keep out moisture. The tubs must be kept closed and in date. When the microcuvette is filled there should be no air bubbles within the chamber and blood should not cover the outside of the microcuvette windows. The loaded microcuvette should be tested within 10 minutes.

The manufacturers recommend the use of blood from capillary (finger prick) samples. Use the fourth drop of blood forming at the puncture site. The blood should flow freely and not be squeezed out.

A number of studies have suggested that capillary sampling may be subject to more errors than venous or arterial samples. In practice provided two samples are analysed and the results are close errors are unlikely. When using venous or arterial blood samples they should be well mixed and inserted immediately into the microcuvette.

Whilst using the HemoCue is straightforward, it requires careful attention to detail and is best demonstrated to clinicians before use. It is recommended that the local haematology laboratory supervises and checks the unit regularly.

The laboratory method of measuring Hb

Many laboratories use commercial cell counters such as Coulter analysers to measure haemoglobin. Haemoglobin is converted to **cyanmethaemoglobin** (HiCN) by addition of the more toxic reagents

potassium cyanide and potassium ferricyanide, and light absorbance at 540nm is measured. However the high dilution of blood sample by reagent (1:251) confers imprecision and turbidity may affect the results. Not least, a trained technician must operate the analysers, delays occur in transporting samples to the lab and samples can get lost in transit.

How does the HemoCue compare to the laboratory?

A study in 1998 compared the HemoCue with the Coulter Max-M (a typical laboratory counter) in 52 arterial blood samples from 13 patients undergoing aortic surgery and 20 routine samples from the laboratory. There was no significant difference between the results.

Cost of the Hemocue

The list price in the UK is £625.00 plus £94.95 for 200 microcuvettes.

Further Information

The UK distributor is HemoCue Ltd, Viking Court, 31 Princess Road, Dronfield, Derbyshire, S18 2LX and the web site address is <http://www.hemocue.co.uk>

Further Reading

1. Evaluation of a new system for hemoglobin measurement. Bridges et.al. American Clinical products Review - April 1987
 2. Evaluation of the HemoCue for measuring intra-operative haemoglobin concentrations: a comparison with the Coulter Max-M. Lardi AM et.al. Anaesthesia. 1998;**53**:349-352
 3. Measurement of haemoglobin using single drops of skin puncture blood: is precision acceptable? Conway AM. Journal of Clinical Pathology, March 1998;**51**:248-250
-

PHARMACOLOGY I

Dr Lauren Barker, Royal Devon and Exeter Hospital, U.K.

Doses of drugs in anaesthesia

Drugs in anaesthesia are commonly expressed in grams, milligrams or micrograms which refer to their mass.

Abbreviations are often used:

Mass	Abbreviation
kilogram	kg
gram	g
milligram	mg
microgram	mcg or the Greek symbol mu is used, μg
nanogram	ng

Examples: 1g flucloxacillin, 500mg thiopentone, 600mcg atropine. The words milli-, micro- and nano- which appear in front of “gram” refer to how many multiples of 10 are present.

- It is possible to convert from grams to nanograms as follows:

$$1\text{g} = 1\,000\text{mg} = 1\,000\,000\text{mcg} = 1\,000\,000\,000\text{ng}$$

- To convert, for example, from micrograms to milligrams:

$$600\text{mcg atropine} = 0.6\text{mg atropine.}$$

Recommended or therapeutic drug doses

Recommended or therapeutic doses enable one to calculate the correct dose of drug for the patient undergoing anaesthesia. They are usually expressed as mg/kg or mcg/kg. Note that this may also be written as $\text{mg}\cdot\text{kg}^{-1}$ or $\text{mcg}\cdot\text{kg}^{-1}$ and are calculated as follows.

Example: the dose of atropine is 20mcg/kg.

- To calculate the correct dose of drug for a patient, multiply the drug dose by the patient’s weight. In a 20kg patient we would give:
 $20\text{mcg/kg} = 20\text{mcg/kg} \times 20\text{kg} = 400\text{mcg} = 0.4\text{mg}$
- To calculate the correct dose of atracurium (0.5mg/kg) for a 70kg adult. $0.5\text{mg/kg} \times 70\text{kg} = 35\text{mg}$

Maximum doses

Maximum doses may refer to local anaesthetic drugs like lignocaine or bupivacaine and indicate the maximum dose of drug that may be given to the patient safely without causing toxicity. In the case of local anaesthetics cardiac arrhythmias or convulsions may result if the maximum dose is exceeded.

Other units for describing drugs

Most commonly we describe the amount of drug present by reference to the mass of drugs (see above). However drug preparations may also be described by how many particles they contain. This gives an idea of the amount of drug present rather than the mass of the drug.

By convention the amount of a substance is measured in moles (abbreviation: mol). A mole has been defined by the Systeme International as the quantity of a substance that contains the same number of particles as there are atoms in 12g of carbon-12. There are 6.022×10^{23} atoms present in 12g carbon-12 and this equals one mole.

This dose method is often used for substances such as potassium (K^+) or sodium (Na^+) in the form of millimole (1mole = 1000 millimole - often written as mmol). This method is useful as sodium or potassium are often prepared with chloride and when administered it is helpful to consider only the amount of Na^+ or K^+ that is given. Therefore it is usually described in mmol.

Example: a solution of normal saline contains 154mmol Na^+ and 154mmol Cl^- in each litre.

Drugs in concentrations

When a substance is dissolved in a liquid it forms a solution. The volume of a solution is expressed in litres or millilitres. 1litre = 1000mls.

The substance dissolved is known as the solute. The amount of solute in a solution is expressed as a concentration. The amount of solute may be described by its mass (grams or milligrams per litre) or by its amount (moles per litre or millimoles per litre).

If the solute has a known chemical formula eg. salt (NaCl), then it is preferable to use mol/l or mmol/l. If

the solute does not have a defined chemical composition (such as a protein), then mg/l or g/l is used.

Some solutions such as local anaesthetics and thiopentone that are used in anaesthesia on a daily basis are expressed as a percentage eg. lignocaine 2% and thiopentone 2.5%. When using drugs prepared in this way it is necessary to calculate the number of mg in ml of solution. This is easiest done by multiplying the percentage of the solution by 10:

- 2% lignocaine x 10 = 20mg/ml
- 0.5% bupivacaine x 10 = 5mg/ml
- 2.5% thiopentone x 10 = 25 mg/ml

The maths behind this calculation is as follows:

- A 2.5% solution means that there is 2.5g of thiopentone in 100ml:

$$\begin{aligned} & 2.5\text{g in } 100\text{ml} \\ & = 2500\text{mg in } 100\text{ml} \\ & = 25\text{mg in } 1 \text{ ml (} 25\text{mg/ml)} \end{aligned}$$

Some solutions such as adrenaline (epinephrine) may be expressed as 1:1000 or 1:10 000 or 1:100 000. This means that in a 1:1000 adrenaline ampoule there is one part adrenaline to 1000 parts solution. To work out how many milligrams of adrenaline are present:

- 1:1000 solution adrenaline
 - = 1g adrenaline in 1000ml solution
 - = 1000mg adrenaline per 1000ml solution
 - = 1mg per ml
- 1:10 000 solution adrenaline
 - = 1g adrenaline in 10 000ml solution
 - = 1000mg per 10 000ml
 - = 1mg per 10ml which can also be expressed as 100mcg per ml

Preparing local anaesthetics with adrenaline

Pre-mixed ampoules of lignocaine 1% and 2% with adrenaline are sometimes not available and it may be necessary to prepare these solutions locally. A 1:200 000 solution means that there is 1 part adrenaline to 200 000 parts of solution (lignocaine in this instance).

In order to produce a 1:200 000 adrenaline solution, add 0.1ml adrenaline 1:1000 to 20ml lignocaine. The method is as follows:

- Take 1ml of adrenaline 1:1000 - dilute to 10mls with saline.

Take 1 ml of this mix which is now 1ml of 1:10 000 adrenaline. Add 19mls lignocaine. Total solution is now 20mls and the original adrenaline has been diluted 200 times = 1:200 000 solution

Other units - milliequivalents (mEq)

Sometimes the term milliequivalent is used in textbooks, although millimoles is the more correct expression. When substances are dissolved in a liquid, they may develop a charge. For example, when salt (NaCl) is dissolved in water, it separates into its two components: Na⁺ and Cl⁻ (these are known as ions). Sodium ions have one positive charge and chloride ions have one negative charge. The word milliequivalent refers to how many ions are present. In this case the number of milliequivalents will be the same as the number of millimoles in solution. Eg. a plasma sodium concentration of 140mEq/l equals 140mmol/l. However, in a magnesium chloride solution (MgCl₂) the magnesium ion has two positive charges so there will be two milliequivalents of magnesium per litre of solution. In this case the number of milliequivalents will not equal the number of millimoles.

Changes in drug names

New rules by the EEC now require the use of the Recommended International Non-proprietary Name (rINN) for drugs. In drugs where there is concern that a name change may pose a serious risk to patients, both the British Approved Name (BAN) and the rINN name will appear on the drug ampoule for at least the next 5 years. In other cases, the new name will appear alone.

Some examples of name changes that will affect anaesthetists are:

UK name	New name (rINN)
adrenaline	epinephrine
noradrenaline	norepinephrine
frusemide	furosemide
lignocaine	lidocaine
thiopentone	thiopental
phenobarbitone	phenobarbital

POST-HERPETIC NEURALGIA

Dr Ed Charlton, Royal Victoria Infirmary, Newcastle upon Tyne UK

Following the initial infection the chicken pox virus may lie in the dorsal horn of the spinal cord for decades before its unwelcome presence becomes evident when it is activated to cause an acute attack of shingles. Typically, this presents as a burning, tingling pain with occasional stabbing components that may precede the onset of small cutaneous vesicles in the distribution of a cutaneous nerve or nerves by as much as two or three days. In turn, this may lead to the unpleasant persistence of pain in the form of post-herpetic neuralgia (PHN). PHN is defined as pain arising or persisting in areas affected by herpes zoster at least three months after the healing of the skin lesions. The early recognition and treatment of herpes zoster prevents viral replication, relieves the acute pain and may reduce the complications of the disease of which PHN is the most feared. However, while it is important to emphasise that treatment may help PHN, there remains a core of patients who are incredibly difficult to treat successfully even in the most optimum circumstances.

Incidence

The incidence of PHN is between 9 and 14% one month after the herpes zoster eruption. There is a definite tendency for PHN to improve with time and as few as 3% of patients may be left with severe PHN after one year. There is no way of predicting who will recover and some series report that as many as 40% of patients with PHN will continue to have long-term problems because of incomplete or no pain relief from our best treatments.

There is no difference between the incidence in males and females, but the incidence is directly related to age; with PHN becoming much more common and more incapacitating as the patient gets older. There is no seasonal incidence and the areas affected tend to be on the chest and abdomen and the ophthalmic division of the trigeminal nerve. One study has shown that black patients have a significantly lower risk of developing herpes zoster than whites. There is an increase in the incidence of herpes zoster with lymphoproliferative disorders (leukaemia / lymphoma) and severe disease and aggressive treatment seem to

increase the likelihood of severe PHN. Herpes zoster seems to be more common in any condition with a change in immune status and is not uncommon in patients with HIV.

Pathology

It is thought that the varicella virus passes to the dorsal root ganglion via the skin during the initial infection (chicken pox) and lies dormant. The latent virus becomes reactivated when immune mechanisms are impaired and the revived activity of the virus is manifest by the rash and the pain. Some cases of pain in PHN may be due to persistent inflammation in the dorsal root ganglion and this may be the reason that anti-inflammatory or antiviral agents can be useful in some individuals. Evidence exists that the small pain fibre activity begins to predominate as the disease advances and that there is increased sensitivity to mechanical stimuli, alpha-adrenergic agonists and to sympathetic efferent activity. These mechanisms suggest that the success of antidepressants in treating PHN may be related to their serotonergic and nor-adrenergic effects.

Clinical considerations

Herpes zoster usually starts with pain, paresthesiae (numbness / tingling) and dysaesthesiae (unpleasant sensations) in the affected dermatomes, followed a few days later by the rash. The pain is usually severe and particularly so in the elderly. The characteristic vesicles usually scab within a week and heal in a month. Generalised zoster is rare but may occur in immunocompromised patients. Infection in the sacral segments can occasionally give rise to urinary retention and there are rare cases of motor nerve involvement, usually in the facial nerve. No evidence exists to support the view that PHN occurs more frequently in the presence of an occult malignancy.

About 5% of patients develop a systemic response to herpes zoster, with fever, stiff neck, headache and nausea. This does not lead to a higher incidence of PHN. Ophthalmic shingles may jeopardise vision and early and aggressive management is advised. Recurrent attacks of herpes zoster are uncommon but

may be associated with immunosuppression or malignant disease.

The scarred areas are at least less sensitive, and often anaesthetic. Paradoxically the skin may exhibit marked superficial pain with light touch (allodynia) or an increased sensitivity to noxious stimulation (hyperesthesia). There may be two types of pain: one a steady burning or aching, the other a paroxysmal, lancinating (stabbing) pain. Both may occur spontaneously and may be aggravated by even the lightest contact with the involved skin. Curiously, firm pressure may lead to pain relief whereas light brushing may be unbearable. Severe pain also may be provoked by physical activity, temperature change, emotional upsets or, in rare cases, by stimuli as trivial as noise from the street or light breezes.

Examination of the affected, scarred skin may reveal that there is a loss of sensation to pinprick, pain and temperature over a far wider area than the scars and in addition, that the area of sensitive or painful skin is even wider still. This phenomenon is thought to be due to the damaged central neurons becoming sensitive to stimuli from a wider area.

Treatment of the acute infection

The acute pain can be treated topically and systemically. Covering the lesions with calamine lotion, petroleum jelly, local anaesthetic creams or an occlusive bandage may give some symptomatic relief. Non-steroidal anti-inflammatory drugs and paracetamol (acetaminophen) with or without codeine or other opioids, may be indicated because of the severity of the pain. There is every justification for using stronger opioids in cases with severe pain that is not relieved by other methods. It makes sense to treat the acute infection as well as possible as this may prevent alterations in the central nervous system that may be responsible for the development of PHN.

It has been suggested that the use of antiviral agents within the first 72 hours may prevent viral replication and thus reduce the severity of the acute eruption and prevent PHN. There is now some evidence to support the use of these agents in this fashion. The use of low dose (10- 50 mg) of amitriptyline at night may reduce the onset of PHN in anyone developing shingles. Use of corticosteroids has been suggested but results of clinical trials have been confusing and their use cannot

be recommended as a method of preventing PHN. The initial infection seems to clear up earlier but there was no effect upon the incidence of PHN. Regional anaesthesia has been the subject of several uncontrolled trials, but no clear answer has been achieved. Suffice it to say that the pain of acute shingles can be relieved by appropriate somatic or sympathetic blockade, or both, and that sometimes this is the only way of getting symptomatic relief in difficult cases.

Treatment of established PHN

- **Antidepressants** have been shown to be effective in the treatment of PHN in a number of well-designed trials. The gold standard for treatment is the tricyclic drug amitriptyline, and this was originally used in 1965 to treat patients with PHN who were thought to be depressed. Good pain relief was noted over almost a year in some patients and it is now known that the effects of amitriptyline on PHN are independent of any action upon depression. The pain relief usually occurs at dosages that are lower than those needed for the effective treatment of depression (50 mg median for PHN 125mg median for depression). Good relief can be expected in over half the patients treated but relief is rarely complete and amitriptyline has significant limitations in the long term because of side effects. These range from annoying (dry mouth, drowsiness, constipation, urinary hesitancy and weight gain) to potentially significant (cardiac conduction defects, memory impairment and hypotension).

As one of the effects of amitriptyline is to potentiate serotonin and noradrenaline in the central nervous system, subsequent research has explored whether agents that work selectively on these neurotransmitters might be more effective and have fewer side effects. Experience with serotonergic agents such as clomipramine, trazodone, and fluoxetine) has been disappointing. However, use of nor-adrenergic agents has been more successful. Desipramine, nortriptyline and maprotiline have all been shown to relieve PHN, at least to some degree. The mixed serotonin- reuptake inhibitor venlafaxine also appears to be effective, but only at the top end of the dose range when it is working like a tricyclic.

- **Neuroleptics.** There is no evidence to support the use of this group of drugs for the treatment of PHN despite reports of success in some small early trials.

- **Anticonvulsants.** It is difficult to be certain about the effects of anticonvulsants in the treatment of PHN. Trials of carbamazepine, phenytoin and sodium valproate have been either unconvincing or the results have been clouded by the concomitant use of antidepressants. The use of carbamazepine for paroxysmal lancinating pain is well established and there may be a small effect upon this sort of pain but there is no apparent effect on continuous pain. Overall, there simply isn't any evidence to support its use in the treatment of PHN.

More recently, gabapentin has been shown to relieve the pain of PHN. The mechanism of action of this agent is not known; the most recent suggestion being that it works via calcium channels. There seems little question that gabapentin is effective in the treatment of PHN in doses ranging between 600 to 3600 mg daily in divided doses. It has a lower side effects profile than amitriptyline but is vastly more expensive.

- **Local anaesthetic drugs** such as lignocaine or mexiletine block voltage sensitive sodium channels to produce membrane stabilization. An infusion of 3 mg/kg of lignocaine given over 30 minutes (monitoring electrocardiogram and blood pressure for signs of systemic toxicity), may predict the response to systemic mexiletine. Dramatic relief of PHN with this therapy is rare.

- **Topical agents.** A variety of topical agents have been tried in PHN (Capsaicin, aspirin and local anaesthetics). Capsaicin, the active ingredient in red peppers and other plants, acts by depleting the neurotransmitter substance P in small primary afferent fibres. Any clinical effect is small and this drug may be best used in conjunction with other treatments. The burning sensation induced by the application of capsaicin may be unpleasant and limit its use clinically. Care must be taken when using this agent to avoid contact with mucous membranes around the eyes and mouth.

Uncontrolled studies have suggested a role for aspirin in a variety of vehicles such as chloroform, ether and Vaseline ointment. Similarly, local anaesthetic creams such as lidocaine and EMLA (a prilocaine based eutectic mixture of local anaesthetics) applied under occlusive dressings may be useful but the effect is small and the expense may be large.

- **Peripherally acting drugs.** As there may still be a residual inflammatory component to some cases of prolonged PHN it makes sense to try the effect of NSAIDs and paracetamol (acetaminophen) in normal clinical doses.

- **Opioids.** There has always been a prejudice against the use of opioids to treat any kind of non-malignant pain but the fact remains that these drugs work effectively in many kinds of severe pain. There is no doubt that the pain of nerve injury, such as is seen with PHN, will respond to opioids. In view of the severity of the pain that may be encountered with PHN there can be no justification for withholding opioids if these are available. Common sense dictates that the dose should be titrated against effect starting with weak opioids, and then escalating strength and dose of opioid to achieve a clinical effect. If side effects supervene without any pain relief, the pain is not opioid sensitive and the drug can be stopped. Studies have shown benefit with the use of tramadol (which has opioid and non-opioid analgesic properties), oxycodone, levorphanol and morphine.

- **Clonidine.** The high density of alpha-2 adrenoreceptors in the dorsal horn of the spinal cord suggests that there should be a role for clonidine in the treatment of PHN. Pain reduction has been reported after this drug has been used epidurally and orally, but there are no properly constructed controlled trials to show benefit is anything more than a theoretical possibility.

- **N-methyl-D-aspartate (NMDA) antagonists.** Ketamine and dextromethorphan are NMDA antagonists that have been tried in the treatment of PHN. It is thought that tricyclics may have NMDA antagonist activity too. Ketamine has helped selected cases when given orally or by injection but there are no controlled studies of the drug given by either method to suggest anything other than occasional help in isolated cases.

- **Miscellaneous therapies.** There seems to be no end to the number of treatment that have been tried to relieve this dreadful problem. These range from vitamin B to snake venom and include serial somatic or sympathetic nerve blocks with local anaesthetic (with and without steroids), serial local anaesthetic infiltrations, prolonged courses of subarachnoid or epidural steroids, hypertonic saline injections,

transcutaneous electrical nerve stimulation, acupuncture, use of hand held vibrators, coolant sprays (such as ethyl chloride) and occlusive dressings such as cling film and cryotherapy.

The surgical treatment of PHN has developed an extensive folklore but it can be stated categorically that no proven surgical cure exists for PHN. Almost any operation can be shown to work a few times but none helps consistently or frequently enough to be worth the effort. Among the surgical treatments shown to be ineffective are local excision, nerve avulsion, cordotomy, rhizotomy and sympathectomy. Theoretically dorsal root entry zone (DREZ) lesioning may be effective but there is insufficient experience anywhere in the world to be able to recommend this approach even in the most severe cases. DREZ lesioning for the treatment of PHN is not advocated by the American Association of Neurosurgeons due to limited efficacy, and the high rate of morbidity. The

use of central electrical stimulation is subject to the same strictures.

Conclusions

Initial treatment of the acute infection should be symptomatic and tailored to the needs of the individual as described earlier. Treatment of persistent PHN should be systematic and begin with simple measures such as an occlusive dressing, simple analgesics and amitriptyline. It is rare for patients to respond to monotherapy and drug combinations up to and including opioids will be the most likely to give success. Each agent should be tried at an adequate dosage and for an adequate time before it can be said to have failed. Drugs that are ineffective or which lead to unacceptable side effects should be replaced by another drug until effective relief is obtained. The eventual combination will be dependent upon what is available and what is affordable.

THE MANAGEMENT OF SEPSIS

Dr Iain Mackenzie, Consultant in Critical Care and Anaesthesia, Addenbrookes Hospital, Cambridge, UK and Dr Iain Wilson, Royal Devon and Exeter Healthcare NHS Trust, Exeter, UK.

Definitions

Immediate Care

Investigations

Monitoring

Treatment of the Underlying Problem

Preserving and Restoring Organ Function

Monitoring the Patient's Progress

Preventing Complications

Ethical Issues and Resource Allocation

Anaesthesia for Critically Ill Patients

DEFINITIONS OF 'SEPSIS' AND 'SYSTEMIC INFLAMMATORY RESPONSE SYNDROME'

Patients are often described as being "septic" or having "septic shock". These terms are used in a variety of ways by different doctors and in 1992 'sepsis' and several new terms were formally defined:

1. Systemic inflammatory response syndrome (SIRS) replaced the previous term 'sepsis syndrome'.

This is the body's response to a variety of severe clinical insults. It is characterised by the presence of two or more of the following features:

- Temperature $>38^{\circ}\text{C}$ or $<36^{\circ}\text{C}$
- Heart rate $> 90/\text{min}$
- Respiratory rate $> 20/\text{min}$ or $\text{PaCO}_2 < 4.3\text{kPa}$
- White cell count $> 12 \times 10^9/\text{l}$

2. Sepsis is defined as SIRS in response to infection.

3. Severe sepsis is sepsis associated with:

- organ dysfunction (altered organ function such that normal physiology cannot be maintained without support)
- hypotension (systolic blood pressure $< 90\text{mmHg}$ or a reduction of $> 40 \text{mmHg}$ from the patient's normal in the absence of other causes of hypotension)

- organ hypoperfusion (revealed by signs such as lactic acidosis, oliguria, acute alteration of mental status).

4. Septic shock describes sepsis with hypotension despite adequate fluid resuscitation.

5. Multiple organ dysfunction syndrome (MODS) describes a state where dysfunction is seen in several organs.

In this article the term SIRS is used. The clinical appearance of a patient with SIRS resulting from infection (sepsis) or other causes (such as burns or pancreatitis) is similar. However there will be differences in the management of the different underlying problem. The initial approach to looking after these patients is similar.

INITIAL ASSESSMENT AND MANAGEMENT

Initial management of a critically ill patient includes:

- Immediate assessment of the airway, breathing and circulation
- A brief history
- A limited examination of the relevant systems of the body.
- A secondary assessment after stabilisation of the patient including a more thorough history, detailed examination by system and appropriate investigations.

Initial Management

Airway and breathing. Respiratory failure is common and may develop at any stage so repeated

Induction and intubation in critically ill patients

Anaesthesia for intubation and ventilation of critically ill patients is hazardous and often poorly tolerated. Consider the following points:

- A trained assistant or second anaesthetist should be present.
- Never leave a hypoxic patient unattended. Give high concentrations of oxygen whilst preparing equipment.
- Obtain wide-bore intravenous access (14G or 16G cannulae). In shocked patients attempt to improve intravascular filling pre-induction, using clinical signs such as heart rate, BP and capillary refill time to guide fluid therapy.
- A patient with severe sepsis / SIRS will have some degree of haemodynamic compromise and induction of anaesthesia will often result in severe hypotension. Induce slowly using small doses of i/v anaesthetic agents. Ketamine, etomidate or diazepam may provide greater haemodynamic stability, although in practice thiopentone may be used provided it is given carefully.
- Respiratory reserve may be poor - preoxygenate for three minutes via a tight-fitting mask and reservoir bag. Patients who are dyspnoeic may require respiratory assistance during this phase.
- Rapid sequence induction and intubation with application of cricoid pressure should be used. Avoid suxamethonium in patients at risk of hyperkalaemia.
- Expect the patient to become hypotensive post induction. This may respond to an infusion of 500 - 1000mls of crystalloid or colloid, but often iv vasopressors are required. Suitable drugs include ephedrine 6 - 9mg iv, metaraminol 2 - 4mg or epinephrine (adrenaline) 1:10 000 in 0.5 - 1ml doses.
- After induction either continue with an anaesthetic or consider another form of sedation to facilitate mechanic ventilation. Frequently a combination of midazolam and morphine are used given either by infusion or intermittent boluses. Neuromuscular blocking drugs may be used but are frequently unnecessary in patients who are critically ill.
- This is a convenient time to pass a nasogastric tube and urinary catheter.

assessments are necessary. A depressed conscious level is the most common cause of airway obstruction. Patients with inadequate airway reflexes should be nursed in the recovery position and if possible intubated and mechanically ventilated.

A clear airway does not indicate effective breathing. Failure of gas exchange may be caused by lung parenchymal problems (pneumonia, lung collapse, pulmonary oedema), failure of the mechanics of ventilation (pneumothorax, haemothorax, airway rupture) or reduced respiratory drive (encephalopathy).

Respiratory failure is suggested by signs of respiratory distress including dyspnoea, increased respiratory rate, use of accessory muscles, cyanosis, confusion, tachycardia, sweating. The diagnosis is made clinically but may be confirmed by pulse oximetry and arterial blood gases. Patients with a depressed conscious level may not react normally to hypoxia and signs of respiratory failure may be difficult to detect. Patients with inadequate ventilation, gas exchange or both require ventilatory support. This usually necessitates intubation and mechanical ventilation although in some patients gas exchange and oxygenation can be improved by the application of continuous positive airway pressure (CPAP) by face mask or non-invasive ventilation.

Circulation. Tachycardia and hypotension are almost universal findings in the septic patient and result from a number of cardiovascular problems. In early sepsis, and in patients who have been partially or fully fluid resuscitated, the low blood pressure and high heart rate are associated with a high cardiac output and a low peripheral vascular resistance with warm peripheries and bounding pulses. In contrast, patients who have not been significantly resuscitated or have presented late in the course of their illness have a low cardiac output and high systemic vascular resistance. These patients are peripherally cold, sweaty, with weak, thready pulses and they need urgent resuscitation. Many patients present with an unclear or mixed clinical picture. However resuscitation aims to restore circulating volume, cardiac output and reversal of hypotension.

Initially infuse i/v crystalloid or colloid rapidly guided by the clinical response. In a peripherally warm, vasodilated patient with a high cardiac output several litres of crystalloid may be needed to establish

adequate intravascular filling. In patients with a mixed or unclear clinical picture, clinical assessment may be difficult. Administering large volumes of fluid to patients with known cardiac disease or myocardial dysfunction related to their acute illness is a problem. In these patients insertion of a central venous catheter will help by measuring the central venous pressure (CVP) to guide fluid resuscitation and to provide a route for infusion of vasopressors or inotropes. A one-off reading of CVP may be misleading but following a trend of measurements and their response to fluid challenges is helpful - see *Update in Anaesthesia No 12*. Urine output should be charted hourly.

History. The primary insult may be self-evident (eg trauma, burns, recent surgery) or more difficult to diagnose (eg pancreatitis, gynaecological sepsis), particularly in unconscious patients.

Examination. The appearance of the patient is variable; they may appear well, warm and well-perfused with bounding pulses or may be cold, vasoconstricted and peripherally cyanosed. The 'warm' and 'cold' patients represent two ends of a spectrum of presentations. The examination will reflect the degree of their illness, their state of intravascular hydration and may reveal the underlying cause.

When looking for an underlying source of infection consider:

- *Central nervous system:* Global (sleepiness, confusion, agitation, coma) or focal (localised abnormality of movement or sensation) neurological dysfunction suggesting meningitis, encephalitis, cerebral malaria or abscess.
- *Respiratory system:* Mucopurulent discharge from the respiratory tract, dyspnoea, lung consolidation or pleural fluid collection.
- *Gastrointestinal tract:* Abdominal pain with guarding and rigidity suggesting peritoneal irritation.
- *Vaginal discharge* or history of termination suggest gynaecological sepsis
- *Skin:* Purulent skin wound, signs of inflammation (redness, pain, swelling, heat) or petechial rash (meningococcaemia).
- The patient with SIRS may have a number of other, non-infective diagnoses. Consider myocardial infarction, pulmonary embolism, diabetic ketoacidosis,

poisoning or drug overdose, eclampsia, cerebrovascular event.

- In some patients the diagnosis is unclear at this stage and treatment has to continue along “best guess” lines.

SECONDARY ASSESSMENT

After the initial assessment and resuscitation, the patient should have a secure airway, adequate ventilation, and cardiovascular resuscitation should have commenced. These need to be rechecked regularly. The priorities during the next phase are:

- Fill in the gaps in the patient’s acute and past medical history.
- Perform a full physical examination by system.

- Perform relevant investigations (see below).
- Communicate with the other teams involved in the patient’s management (e.g. general surgeons for intra-abdominal infection, gynaecologists for gynaecological sepsis).
- Continue resuscitation.

Perform investigations to confirm or clarify problems that are clinically evident, or to look for complications that are likely in each particular clinical setting. Investigations will be governed by the availability of these tests in each centre and the time available. For example, for a septic patient with abdominal signs in a centre with no access to radiological facilities, diagnostic laparotomy may be the definitive investigation (and treatment). Table 2 shows common initial investigations.

Haematological	FBC (raised WCC common, may be reduced in overwhelming sepsis) Coagulation screen Thick and thin blood film (malarial parasites) Confirm sickle cell / thalassaemia status
Biochemistry	Sodium, potassium, urea, creatinine Glucose (usually increased in SIRS) Amylase (raised in pancreatitis, ischaemic bowel, perforated bowel) Liver function tests Cardiac enzymes if infarct likely CPK in crush injuries
Arterial blood gas	Respiratory function Acid-base balance
ECG	To exclude cardiac causes of hypotension or to differentiate sinus tachycardia from arrhythmia
Chest Xray	To confirm clinical findings in chest (e.g. acute pneumonia), to investigate underlying lung disease and confirm the position of an endotracheal tube and central venous line
Microbiological	To confirm the presence of infection - Samples depend on history and examination. A ‘septic screen’ may be required in difficult cases. <ul style="list-style-type: none"> ● Blood cultures (ideally three sets during pyrexial episodes). ● Sputum (protected catheter specimens or broncho-alveolar lavage may be available for intubated, ventilated patients). ● Mid-stream urine (MSU) or catheter specimen of urine (CSU). ● CSF where indicated via lumbar puncture. ● Wound swabs from any suspected sites (including old cannula sites). ● High vaginal swab. ● Stool for ova, cysts and parasites. ● Deeper infection may be clinically or radiologically evident. Samples may be amenable to percutaneous aspiration or sent after surgical drainage or debridement.

Monitoring is not dependent on expensive equipment, but it requires the continuous presence of trained nursing staff. Clear documentation aids the assessment of subtle changes in the patient's clinical state. Patients with severe SIRS / sepsis should have observations recorded hourly. Record body temperature, pulse, blood pressure, urine output, CVP, respiratory rate and SpO₂ (if available). Accurate fluid balance is essential - insensible losses may be very significant in hot climates. Ideally measure the patient's temperature centrally (rectal or nasopharyngeal). Other sites include the axilla or mouth. Of these, the axilla is the least accurate but most convenient; whilst the rectal route is the most accurate but least convenient. Always use the same site.

TREATMENT OF THE UNDERLYING PROBLEM

Clearly this depends on the nature of the initial insult and may be straightforward (oxygen, antibiotics and chest physiotherapy for a lobar pneumonia), or complex involving different specialities (orthopaedics, general and plastic surgery for major trauma). Infection is common, either as cause, or as a secondary complication. Treatment of infection may involve:

Antibiotic therapy. The initial antibiotic prescription is a 'best guess', and will depend on the clinical picture of the patient, local patterns of antibiotic resistance and the local availability of antibiotics. It should be broad enough to cover the most likely pathogens, but not so broad as to encourage antibiotic resistance. The advice of a local microbiologist or infectious diseases specialist is valuable.

Surgical debridement. Pus-filled cavities (abscess, empyema), necrotic tissue, infected tissue or gross tissue contamination (open wounds, peritonitis) cannot be treated by antibiotics alone and must be treated surgically at the earliest opportunity. The surgical team should assess the patient as soon as possible. Anaesthesia for these patients is discussed later in this article.

THERAPEUTIC STRATEGIES FOR PRESERVING ORGAN FUNCTION

Organ failure results from inadequate organ oxygenation due to poor perfusion. Strategies to maintain or restore organ function are **general**, aimed at improving delivery of oxygen and nutrients to all tissues, or **organ-specific** (e.g. the kidney and gut).

Improving Oxygen Delivery

Oxygen delivery to the tissues, (DO₂) is defined as:
 $DO_2 = \text{cardiac output} \times \text{haemoglobin level} \times \text{oxygen saturation}$

Each of these three factors should be optimised to improve oxygen delivery.

Cardiac output. In SIRS the cardiac output may be low, high or normal. Whilst cardiac output at normal or supranormal levels is required to maintain oxygen delivery, maintenance of blood pressure itself is also important to ensure perfusion pressure is adequate (eg filtration at the kidney). Although most organs are capable of some autoregulation, this mechanism cannot always compensate for the circulatory disturbance in sepsis. This is why a vasodilated patient with a high cardiac output needs intervention to elevate their blood pressure.

The main treatments for maintaining cardiovascular function are correction of hypovolaemia with fluid therapy, inotropes and vasopressor agents.

- Correction of hypovolaemia (fluid therapy). Vasodilation causes blood to pool in the periphery, and abnormal capillary permeability results in fluid leak into the tissues. These changes decrease the relative blood volume (by vasodilation) and absolute blood volume (by capillary leak) causing a fall in the preload of the heart and therefore a decrease in cardiac output. Monitor progress clinically: a satisfactory response to fluid therapy is suggested by a falling heart rate, increase in the blood pressure, decrease in the capillary refill time and improvement in organ function. A central venous catheter may be helpful if the clinical picture is hard to interpret or mixed (co-existent cardiac disease).

Clear benefits of colloid over crystalloid have not been demonstrated, but crystalloid redistributes rapidly into the whole extracellular volume (about 14 litres in a 70 kg man) and so larger volumes must be given for intravascular resuscitation. In anaemic patients blood is often required.

- Use of inotropic and vasopressor (vasoconstrictor) agents. If the blood pressure remains low after the patient is judged to be adequately intravascularly filled, the patient either has inadequate myocardial 'pump' function or has a degree of vasodilation which cannot be overcome by fluid therapy alone. Sometimes patients present as clear-

Infusions of inotropic and vasopressor drugs

Adrenaline and Noradrenaline:	Mix 5 mg in 50ml 5% glucose. This gives a mixture of 1 in 10 000 adrenaline. Start at low dose (1 to 5 ml/hr) and titrate to the desired blood pressure Noradrenaline may be available in 4 mg vials - mix 4 mg in 40ml 5% glucose and use as above.
Dobutamine and Dopamine:	Multiply the patient's weight in kg by three. Make this number of milligrams of dobutamine or dopamine up to 50 ml in dextrose or saline. Infusion of this solution at a particular rate in ml/hr gives the same number in mcg/kg/min (e.g. 2ml/hr = 2mcg/kg/min.)

cut examples of one of these two syndromes, but more often patients have a mixture of clinical signs. If the patient appears vasodilated with a hyperdynamic circulation an agent with vasopressor (α adrenoreceptor agonist) properties, such as noradrenaline (norepinephrine) is appropriate to elevate the blood pressure.

If the patient is cool peripherally (has a large core to peripheral temperature difference), has signs of poor organ perfusion and/or a low blood pressure then an agent with more positive inotropic properties is the best choice. Examples are adrenaline (epinephrine), dobutamine or dopamine.

Inotropes should be given through a central venous catheter and direct intra-arterial blood pressure measurement is preferable for accurate, continuous readings. Proposed regimens for use of these drugs are shown below. In practice few of these drugs have 'pure' effects; noradrenaline also has positive inotropic effects via stimulation of β_1 -adrenoreceptors. Combinations of vasopressor and inotropic drugs are often used.

If the clinical picture is difficult to interpret, other means of investigation are available in some centres. Pulmonary artery flotation catheters (Swan-Ganz catheters) indirectly measure the left atrial pressure, which may be a more accurate measure of intravascular volume status. The saturation of blood sampled from the pulmonary artery gives the mixed venous blood oxygen saturation which can be used to assess adequacy of oxygen delivery. Use of trans-oesophageal doppler is increasing.

Oxygen saturation and gas exchange. The majority of patients with severe sepsis require intubation and

ventilation and almost 50% go on to develop problems with gas exchange. Lung problems associated with SIRS is termed 'Acute Lung Injury' (ALI). 'Acute Respiratory Distress Syndrome' (ARDS) describes the most severe form of ALI. In both cases the lungs become oedematous and damaged and are less able to take up oxygen or eliminate carbon dioxide. ALI may resolve with treatment of the underlying cause of the SIRS, or progress to a stage where lung fibrosis takes place. Steroids may have a role in the treatment of late refractory ALI / ARDS, but are thought to be ineffective in the early stages. Some of the lung damage sustained during critical illness may be due to mechanical ventilation: excessive driving pressure causes over-expansion of and damage to alveoli. In patients with ALI, ventilators should be set at a more protective ventilation strategy in patients with:

- Limitation of plateau pressure to less than 35 cm H₂O
- Use of smaller tidal volumes (up to 8 ml/kg)
- Lower target minute volumes resulting in PaCO₂ values higher than normal (so called 'permissive hypercapnia'). This results in a respiratory acidosis which is usually well tolerated, provided the arterial pH does not fall below 7.2.
- Use of pressure-control rather than volume-control ventilation.
- Higher positive end-expiratory pressures (PEEP, 10 or 12 cm H₂O instead of 5 or 6cm H₂O)
- Longer inflation phase with I:E ratio of approximately 1:1, to improve the distribution of gas within the lung.

- Avoid an FiO_2 above 60% if possible - aim for SpO_2 93-95%.

Ventilator-associated pneumonia (VAP) is a frequent complication of ventilation. This is thought to arise from contamination of the respiratory tract by aspiration of material regurgitated from the stomach ('micro-aspiration' around the endotracheal tube cuff). Techniques which are thought to reduce the incidence of VAP include:

- Aseptic technique when suctioning patients
- Nursing the patient semi-recumbent instead of completely flat
- Avoiding the use of proton-pump inhibitors or H_2 -antagonists which encourage bacterial growth in the stomach due to loss of acidity. Establishing early nasogastric feeding
- Ensuring that the cuff of the endotracheal tube is correctly inflated
- Avoiding re-intubation or manipulation of the airway circuit

Treatment of anaemia. Recent studies show that transfusion of blood to critically ill patients to maintain a haemoglobin level of greater than 10 g/dl does not alter the patients outcome. With the multiple potential problems associated with blood transfusion, in the absence of ischaemic heart disease, it is reasonable to allow the haemoglobin to remain at 7 to 9 g/dl.

Nutrient supply and hormonal changes in SIRS. Insulin secretion is reduced with the stress of severe illness whilst cortisol and growth hormone secretion both increase. Patients are prone to hyperglycaemia due to the insulin-antagonism of these hormones and drugs such as adrenaline (epinephrine). A slow intravenous infusion of an insulin solution (1 unit per ml) may be required to maintain normal blood sugar levels (5 to 9 mmol/l), but if this is not practical then adequate glycaemic control can be achieved with intermittent subcutaneous injections of insulin. Check the blood sugar at regular intervals.

During a prolonged illness the patient's metabolic requirements will be increased by the effects of fever and infection, and the patient will become catabolic, breaking down their own tissues (especially muscle) to use as metabolic fuel. This process cannot be reversed, but can be limited to some extent by

supplying the patient with appropriate quantities of energy (in the form of fat and carbohydrate), nitrogen (in the form of protein, peptides or amino acids), minerals and vitamins. Feeding via the enteral route (e.g. via a nasogastric tube) is preferable; proposed benefits include reduced 'stress' ulceration in the stomach, preservation of bowel mucosal function and reduction of **bacterial translocation** from the bowel lumen into the circulation (see below). Some conditions preclude enteral feeding (recent bowel resection) but other problems may be overcome (e.g. nasojejunal tube for pancreatitis or percutaneous gastrostomy for oesophageal disease). Intravenous nutrition may be used if enteral feeding is not possible, but is expensive, and associated with a number of significant complications (most notably infection).

Organ-specific Strategies

Gastrointestinal tract. The bowel may act as the 'motor' for MODS, by the mechanism of bacterial translocation across damaged mucosa whose integrity has been damaged by hypoxia. As described above, early enteral feeding is the main preventative measure to counter this.

H_2 -antagonists (e.g. ranitidine) and proton pump inhibitors (e.g. omeprazole) have been used to reduce mucosal damage in patients who cannot be fed enterally. The disadvantage is that by reducing gastric acidity these drugs allow bacterial overgrowth and may increase the likelihood of ventilator associated pneumonia and bacterial translocation. Sucralfate is a cheaper alternative which gives some mucosal protection without reducing gastric acidity.

Liver. In the acute phase of sepsis (within the first 24 or 48 hours) the liver may be damaged by periods of low blood pressure, reflected in sharp rises in circulating liver enzymes (lactate dehydrogenase and both aspartate and alanine transaminase). With adequate resuscitation this damage is self-limiting and reversible. Maintenance of liver function depends on effective resuscitation, rapid removal of the septic focus, appropriate antibiotic treatment, early nutritional support and the avoidance of further damage. Hepatic damage may cause encephalopathy, coagulopathy and hypoglycaemia.

Kidneys. The ion channels in the tubular epithelium of the renal medulla are energy (and therefore oxygen) dependent and so particularly sensitive to episodes of

hypotension and hypoxia. Up to 65 % of patients with sepsis develop abnormalities of renal function and if renal replacement therapy (haemofiltration or haemodialysis) is required the mortality is as high as 75 %. Indications for renal replacement therapy include, severe or refractory hyperkalaemia, severe metabolic acidosis, low or absent urine output or symptomatic uraemia (e.g. pericardial effusion).

If a patient is oliguric, consider the following:

- **Exclude obstructive causes** - flush the urinary catheter, consider urethral damage in trauma.
- **Fluid resuscitation.** Reduction in blood volume stimulates the release of renin, anti-diuretic hormone and activation of the sympathetic nervous system, reducing the volume of urine produced by the kidney. These effects may be reversed by adequate fluid resuscitation guided clinically and, if necessary, using a central venous catheter.
- **Blood pressure.** The kidney autoregulates the filtration pressure in the glomerulus by altering the resistance of afferent and efferent arterioles. Autoregulation fails if the mean arterial blood pressure falls below about 60mm Hg and urine flow decreases or stops. Correction of hypovolaemia may not restore the blood pressure. Use an inotrope or vasopressor as described above.

- **Nephrotoxic agents.** Stop non-steroidal anti-inflammatory drugs, angiotensin-converting enzyme (ACE) inhibitors and avoid radiographic contrast media. Levels of aminoglycoside antibiotics (gentamicin, netilmicin) and vancomycin should be checked.

- **Diuretics.** Loop diuretics such as frusemide may establish a diuresis but should only be used after optimal restoration of intravascular volume. By inhibiting the active transport of ions in the loop of Henle loop diuretics may offer some protection to tubular cells from hypoxic damage.

If these strategies do not restore urine flow, then acute renal failure has occurred. In the absence of specific nephrotoxic agents the cause is likely to be acute tubular necrosis, which in most cases is reversible. The time to return of renal function is variable (from a few days to several weeks) and in the interim some form of renal replacement is necessary to control hypervolaemia, acidosis, hyperkalaemia and uraemia. The choice is largely dependant on local availability and transfer to another centre may be necessary. Monitor the patient using daily weight, and measurement of electrolytes, urea and creatinine.

MONITORING THE PATIENT'S PROGRESS

Failure to improve or deterioration at any stage should prompt thorough reassessment of the patient (ABC,

Complications following sepsis

Complications of intubation and mechanical ventilation	Pneumonia Pneumothorax Vocal cord damage Tracheal stenosis Difficulty weaning from ventilatory support
Hospital-acquired (nosocomial) infections	Cellulitis at the site of venous or arterial cannulae Cannula-related septicemia Urinary-tract infections Blood and blood-product infections (HIV, hepatitis B)
Complications secondary to immobility and severe illness	Pressure sores Peripheral nerve palsies Corneal abrasions Pulmonary emboli and/or deep vein thromboses Malnutrition and weakness
Drug-related	Kidney damage (aminoglycoside antibiotics)
Disturbance of sleep / wake cycle	

history, examination etc). Consider whether the original diagnosis is correct, a new diagnosis has evolved, the current treatment is appropriate and correctly instigated, or whether a complication has developed. Signs of deterioration may include:

- Persistent or worsening tachycardia
- Persistently elevated or swinging temperature
- Rising white cell count, C-reactive protein
- Fall in blood pressure, or increased requirement for vasopressor drugs to maintain the same blood pressure
- Deteriorating renal output
- Deterioration in conscious level
- Deterioration in respiratory function

PREVENTING COMPLICATIONS

Patients with SIRS may suffer depression of immune function and many of the procedures performed on intensive care units breach the body's natural defences (e.g. orotracheal intubation, peripheral cannulae and central venous cannulae) and leave the patient prone to secondary infections. These and other complications are listed below.

Prevention of Infection

Medical staff have been implicated in the spread of infectious agents between patients. All staff must wash their hands before and after attending to a patient. Equipment (such as thermometers, stethoscopes, bed pans) should not be shared between patients if possible, but where this is necessary the equipment should be thoroughly cleaned between patients. Staff should protect themselves and their clothes from becoming contaminated with biological material by wearing (ideally disposable) aprons and gloves. Visitors should be discouraged from moving between patients. Patients should be washed daily and never be left in soiled bed linen. Wounds, including drain sites and intravenous cannulae sites, should be inspected, cleaned and dressed at regular intervals. Intravenous cannulae and central lines should be removed as soon as practical. Some units have strict protocols governing the replacement of in-dwelling cannulae after a set number of days, other units replace the cannula when clinically indicated.

Immobility and Severe Illness

Patients immobilised by sedation or severe illness are vulnerable to complications that can be prevented by good nursing care. Pressure damage can be prevented by re-positioning the patient every two to four hours, and by replacing wet linen. Particular attention should be paid to the skin over bony prominences, such as the heels and elbows, by padding these areas with cotton-wool, lint or even sheep's wool. Eye damage can be prevented by taping the eyes shut or application of protective gel. Joint stiffness and peripheral oedema may both benefit from passive movement of both the legs and arms. If there is a severe shortage of nursing staff all of these activities can be carried out by the patient's relatives if they are given the appropriate training and encouragement. In longer stay patients physiotherapy is essential to minimise muscle wasting and maintain good active and passive range of movement. Critical illness neuropathy and myopathy are common complications of SIRS.

ETHICAL ISSUES AND RESOURCE ALLOCATION

There is no predictive scoring system which gives accurate predictions of outcome for individual patients. Survival from an episode of severe SIRS/sepsis is dependent the patient's age, previous health and the time delay before the onset of medical intervention, as well as the appropriateness and quality of medical care. Few countries have limitless resources, and so difficult decisions face all intensive care doctors when deciding between the potential benefits for one critically ill patient and need for provision of healthcare to several less critically ill patients.

APPENDIX

Anaesthesia for the Septic Patient

The surgical drainage of abscess cavities, laparotomies, debridement of infected wounds or amputation of gangrenous limbs may be central to the successful treatment of a patient with severe sepsis. Surgery and anaesthesia is often required, even in patients in poor clinical condition.

Pre-operative Preparation

The time taken to improve a patient's condition before surgery must be balanced against the urgency to surgically treat the underlying problem. Recent studies

have shown that the outcome from surgery in these high risk patients is improved if the patient's condition is 'optimised' preoperatively. When surgery can be delayed (even for a few hours), attempts should be made to resuscitate the patient to ensure adequate oxygen delivery, cardiac output and blood pressure. This is often easiest done in theatre, recovery or ICU. In a few patients immediate surgery is lifesaving and should be carried out as soon as practical (eg necrotising fasciitis). In these patients preparation time is limited but initial resuscitation (airway, breathing and circulation) should be completed and continuing resuscitation carried out during anaesthesia. Common problems in the perioperative period include anaemia, hypotension, coagulation disturbance, electrolyte disturbance (particularly hyper or hypokalaemia) and acidosis.

Regional or General Anaesthesia?

Physiological stability during anaesthesia is compromised by the combined effects of sepsis, anaesthesia, blood loss and surgical stress. Close monitoring is required because rapid changes in physiological parameters may occur.

When inducing anaesthesia in a septic patient the same considerations which are described in the airway / breathing section of resuscitation apply. Supplementary analgesia may be needed and intravenous or inhalational agents can be used to maintain anaesthesia. Use smaller doses of cardiovascularly active drugs to assess the patient's response. Ketamine anaesthesia is widely used in these high risk patients, although in this situation it may be cardiovascularly depressant and does not protect the airway as effectively as an endotracheal tube. Following induction of anaesthesia there is a reduction in sympathetic tone that often results in hypotension which may need treating by i/v infusion of fluids and a vasopressor.

Neuraxial blockade (spinal and extradural anaesthesia) should only be considered if recent blood tests have

shown the clotting to be normal. The haemodynamic effects of these techniques in the setting of cardiovascular compromise may be devastating and hard to reverse. A further concern is the risk of epidural abscess complicating an epidural haematoma formation. The evidence is not clear but the risk is likely to be increased in patients who are frankly septic. Peripheral nerve blocks or regional infiltration may be used and are very effective at minimising the sympathetic response to a painful stimulus, whilst avoiding the systemic effects of opioids.

Further reading

1. American College of Chest Physicians/Society of Critical Care Medicine Consensus Conference: Definitions for sepsis and organ failure and guidelines for the use of innovative therapies in sepsis. *Critical Care Medicine* 1992;20:864-74.
2. Oxford Textbook of Critical Care. Editors: Webb AR, Shapiro MJ, Singer M and Suter PM. Oxford University Press 1999. Oxford, New York, Tokyo.
3. Alderson P, Schierhout G, Roberts I, Bunn F. Colloid versus crystalloid for fluid resuscitation in critically ill patients. *Cochrane Database Systemic Review*. 2000;(2):CD000567.
4. Meduri GU. Levels of evidence for the pharmacological effectiveness of prolonged methylprednisolone treatment in unresolving ARDS. *Chest* 1999; 116:S116-118.
5. Amato MB et al. Effect of protective-ventilation strategy on mortality in the acute respiratory distress syndrome. *New England Journal of Medicine* 1998;338:347-54.
6. Cook D. Ventilator-associated pneumonia: perspectives on the burden of illness. *Intensive Care Medicine* 2000;26:S31-7.
7. Hebert PC et al. A multicenter, randomised controlled clinical trial of transfusion requirements in critical care. *New England Journal of Medicine* 1999;340:409-17.
8. Nathens AB and Marshall JC. Selective decontamination of the digestive tract in surgical patients: a systematic review of the evidence. *Archives of Surgery* 1999;134:170-6.

ANAESTHETIC SELF-EVALUATION

C. Behrens and R. Law, Royal Shrewsbury Hospital, Shrewsbury.

Multiple Choice Questions

1. Hypotension may be caused by:
 - a. Neostigmine
 - b. Spinal anaesthesia
 - c. IPPV
 - d. Hypovolaemia
 - e. Vecuronium.
2. The oxygen-haemoglobin dissociation curve is shifted to the right by:
 - a. Alkalosis
 - b. Hypothermia
 - c. Nitric oxide
 - d. Respiratory depression
 - e. Fetal haemoglobin.
3. In the neonate:
 - a. The cricoid cartilage is the narrowest part of the upper airway
 - b. The spinal cord ends at L1
 - c. Free drug levels may be higher due to lower plasma albumin levels
 - d. Shivering is effective in increasing body temperature
 - e. Greater chest wall compliance decreases the FRC.
4. The following statements regarding obesity are true:
 - a. A person with a BMI of 20-25kg/m² is considered obese
 - b. Oxygen consumption increases with obesity
 - c. A blood pressure cuff that is too small will underestimate the blood pressure
 - d. Intramuscular opioid is the analgesic method of choice in an obese patient
 - e. There is a significant risk of DVT in obese surgical patients.
5. The physiological response to major surgery includes:
 - a. Hyperglycaemia
 - b. Decreased protein metabolism
 - c. Increased sympathetic nervous system activity
 - d. An increase in urine output due to a reduction in ADH secretion
 - e. Increased fibrinogen levels.
6. Thiopentone:
 - a. Possibly exerts some of its effects via the GABA A receptor complex
 - b. Dose requirements are lower in shocked patients
 - c. Reduces cerebral oxygen utilisation
 - d. Is safe in porphyria because it has no effect on ALA synthase
 - e. Followed by suxamethonium is absolutely contra-indicated in patients with open eye injuries.
7. Ketamine:
 - a. Has active metabolites
 - b. Clearance is reduced by halothane
 - c. Preserves cerebrovascular responsiveness to CO₂
 - d. Is relatively contra-indicated as the sole agent in patients with ischaemic heart disease
 - e. May be added to solutions used for caudal anaesthesia to prolong analgesia.
8. With regard to volatile agents:
 - a. Enflurane is the agent of choice in a patient with epilepsy
 - b. Isoflurane is more extensively metabolised than halothane
 - c. Ether causes sympathetic stimulation
 - d. Sevoflurane's high blood-gas partition coefficient allows for faster induction of anaesthesia than with halothane
 - e. Desflurane has a boiling point of 23.5°C thus cannot be used in a standard vaporiser.
9. The following drugs cause recognised interactions:
 - a. Alcohol and midazolam
 - b. Aminophylline and erythromycin

- c. Vecuronium and gentamicin
 - d. Verapamil and propranolol
 - e. Halothane and adrenaline (epinephrine).
10. The hazards of intra-operative blood transfusions include:
- a. Coagulopathy
 - b. A shift in the oxygen-haemoglobin dissociation curve
 - c. Hypokalaemia
 - d. Metabolic alkalosis
 - e. Malaria.
11. Non-depolarising neuromuscular blockade:
- a. Can be monitored by means of double-burst stimulation
 - b. Does not show post-tetanic facilitation
 - c. Is achieved by competitive agonists of postsynaptic acetylcholine receptors at the neuromuscular junction
 - d. Is antagonised by volatile inhalational agents
 - e. Is characterised by fasciculations.
12. A pulse oximeter:
- a. Utilises the Beer-Lambert law
 - b. Reliably detects SpO₂ of 50%
 - c. Is reliable when monitoring patients extracted from house fires
 - d. Is unaffected by pigmented skin
 - e. Is considered an essential monitor during anaesthesia.
13. With regard to anaesthetic breathing systems:
- a. The Lack system is a co-axial form of the Mapleson D system
 - b. The Mapleson A system is inefficient when used for spontaneous ventilation
 - c. Mapleson's classification describes the T-piece as a Mapleson C system
 - d. The Jackson-Rees modification of Ayre's T-piece has low resistance to expiration
 - e. With circle systems, the lowest fresh gas flow that can safely be used is 800ml/minute.
14. The following statements about the Rotameter are true:
- a. It is a constant pressure variable orifice flow meter
 - b. Viscosity is the most important determinant of flow at high flow rates
 - c. Small changes in temperature cause significant inaccuracies in flow measurement
 - d. Static electricity may cause inaccuracies in flow meters
 - e. CO₂ can safely be administered via a properly calibrated air Rotameter.
15. In obstetric anaesthesia:
- a. A sensory block to T9-10 is adequate for Caesarean Section under regional blockade
 - b. Sodium citrate 0.3 molar is a suitable antacid
 - c. The risk of hypoxia (maternal) is higher than in non-pregnant patients
 - d. The incidence of post-dural puncture headache is reduced with pencil point needles
 - e. NSAIDs are useful for post-operative analgesia in healthy patients following Caesarean Section.
16. When performing regional blocks:
- a. An axillary brachial plexus block is appropriate for shoulder surgery
 - b. The tourniquet can be released 10 minutes after injection of local anaesthetic for a Bier's block
 - c. There is a greater risk of pneumothorax with the supraclavicular than axillary approach to a brachial plexus block
 - d. A 3-in-1 block is an appropriate technique for blocking the lumbar plexus
 - e. Spinal opioids can cause itching.
17. With regard to hepatitis and HIV:
- a. The risk of transmission of HBV through a needlestick injury is similar to that for HIV
 - b. Immunisation against HBV is effective provided that boosters are received every 2 years
 - c. HIV is killed by immersion in hypochlorite solution
 - d. HIV-infected patients commonly present for abdominal surgery
 - e. HIV can cause myocarditis.

18. Problems with intubation are more common in patients:
- With a thyromental distance of $> 6.5\text{cm}$
 - Having a Caesarean Section near term
 - With rheumatoid arthritis
 - With acromegaly
 - With Down's syndrome.
19. In the neck:
- The thyroid cartilage is palpable at the level of C6
 - The internal laryngeal nerve pierces the thyrohyoid membrane
 - The vagus nerve lies outside the carotid sheath
 - The common carotid artery bifurcates at level C6
 - The subclavian artery passes anterior to scalenus anterior above the first rib.
20. Tension pneumothorax:
- May follow cannulation of the internal jugular vein
 - Is diagnosed only on PA erect chest X-ray
 - May cause tracheal deviation
 - Is treated definitively by IPPV to maintain oxygenation
 - Should be considered as a cause of cardiac arrest.

Clinical Scenario

You are asked to anaesthetise a 3-year-old child who requires an operation to stop bleeding 4 hours after an adenotonsillectomy. Describe your preoperative assessment, preparation, and anaesthetic technique for this case.

X-Rays

- What abnormalities are shown on these x-rays? They are of the same patient, taken two weeks apart.
- If anaesthesia was requested for a minor diagnostic procedure, describe how you would investigate the patient preoperatively and the anaesthetic technique you would employ.



Interpret the following ECG's

1.

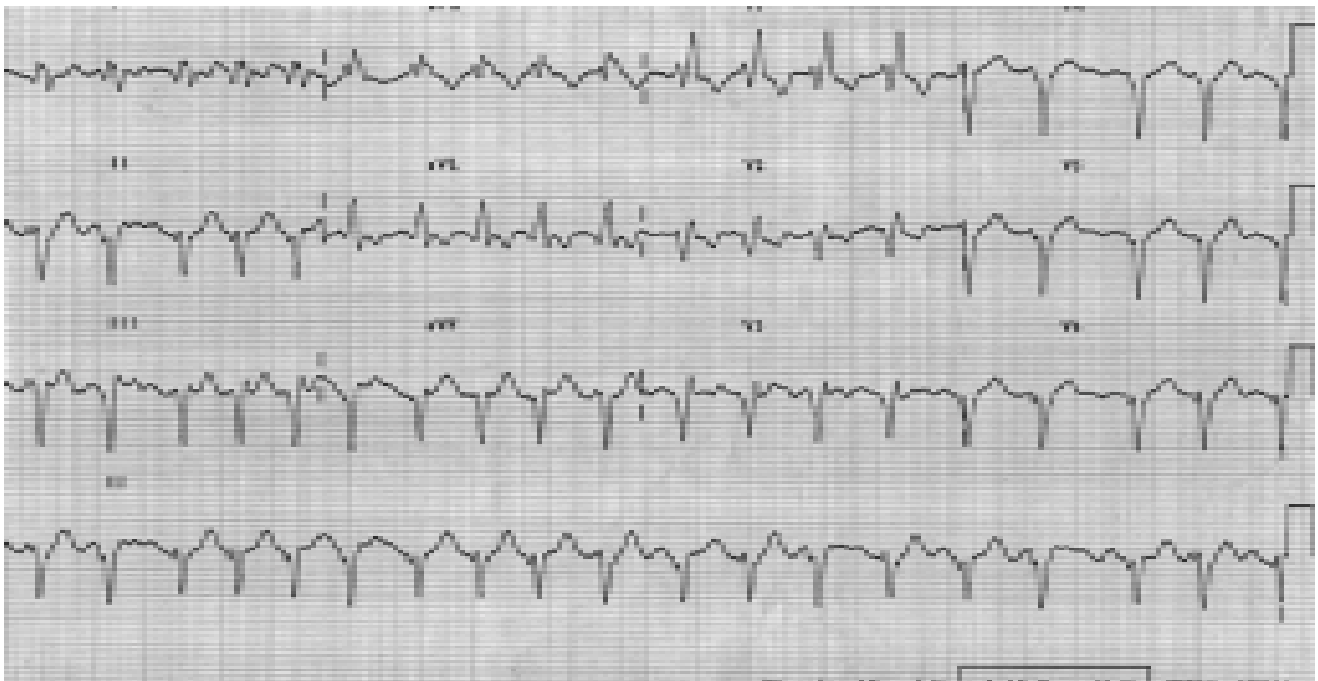

2.

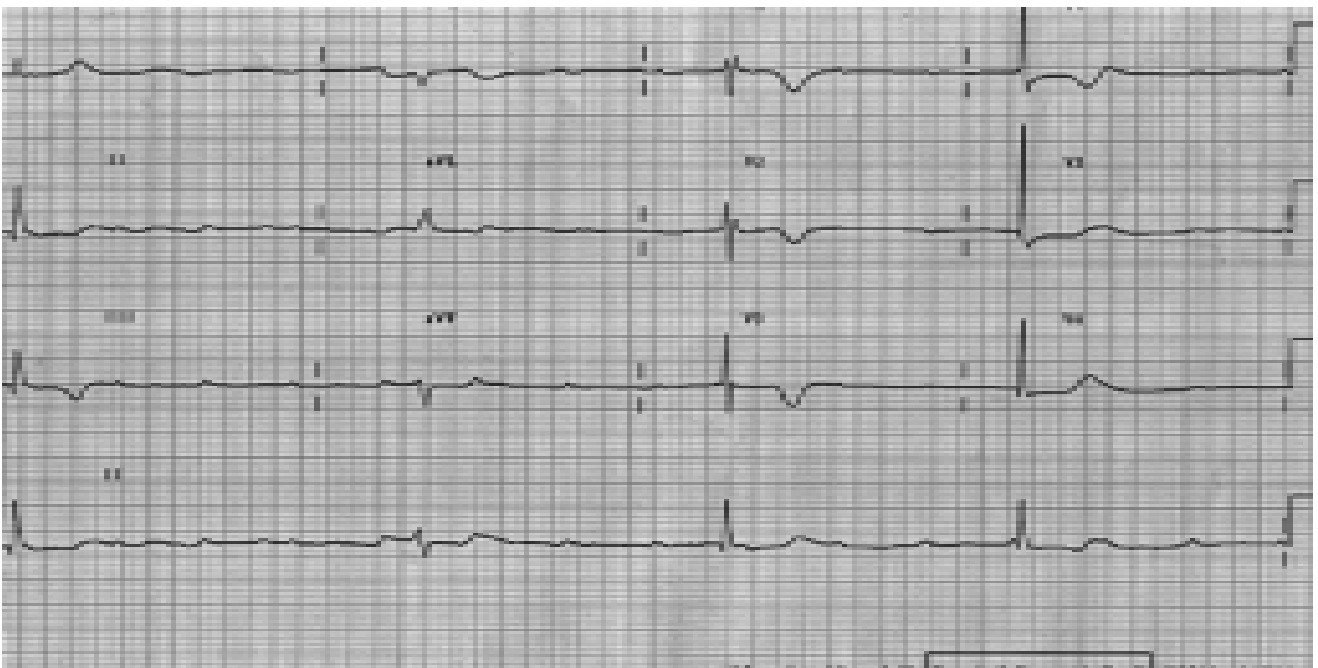

Answers

Multiple Choice Questions

1. Hypotension:
 - a. **T** - If used without atropine or glycopyrrolate, neostigmine may cause bradycardia that may in turn lead to hypotension.
 - b. **T** - The vasodilation resulting from sympathetic blockade reduces venous return, stroke volume and cardiac output.
 - c. **T** - IPPV also reduces venous return.
 - d. **T** - Cardiac output drops with hypovolaemia.
 - e. **F** - Vecuronium has little effect on blood pressure since there is minimal histamine release, ganglion blockade or vagal blockade.

2. The oxygen-haemoglobin dissociation curve is shifted to the right by:
 - a. **F** - The curve is shifted to the left by alkalosis, hypothermia, hypocapnia and reduced 2,3-DPG levels. Acidosis, hyperthermia, hypercarbia and raised 2,3-DPG levels shift it to the right.
 - b. **F**
 - c. **F** - Nitric oxide has no effect on the ODC.
 - d. **T** - Because of carbon dioxide retention.
 - e. **F** - Fetal haemoglobin, methaemoglobin &

carbon monoxide poisoning shift the curve to the left.

3. Neonate:
 - a. **T** - A small decrease in diameter (e.g. due to oedema) may cause a large increase in airway resistance. In the adult the glottis is the narrowest part of the upper airway.
 - b. **F** - The spinal cord ends at L3 in the newborn. The dural sac extends as far as S3-S4, as opposed to S1 in the adult.

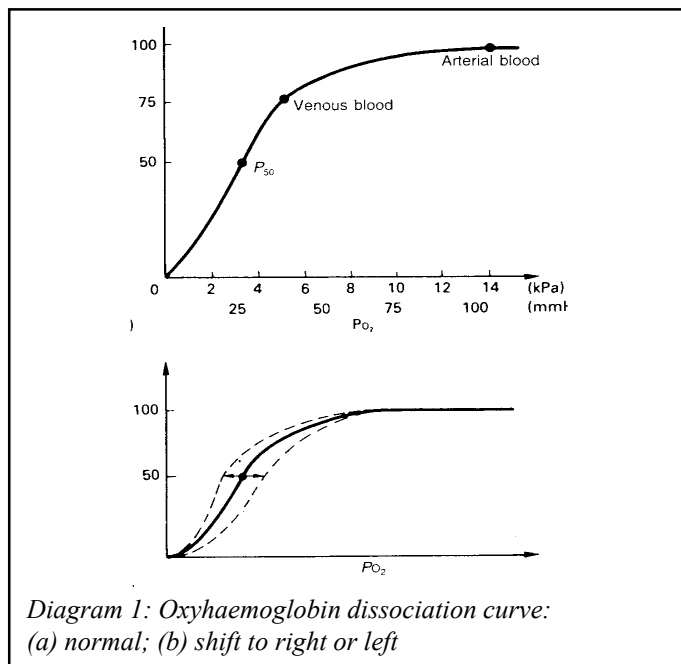
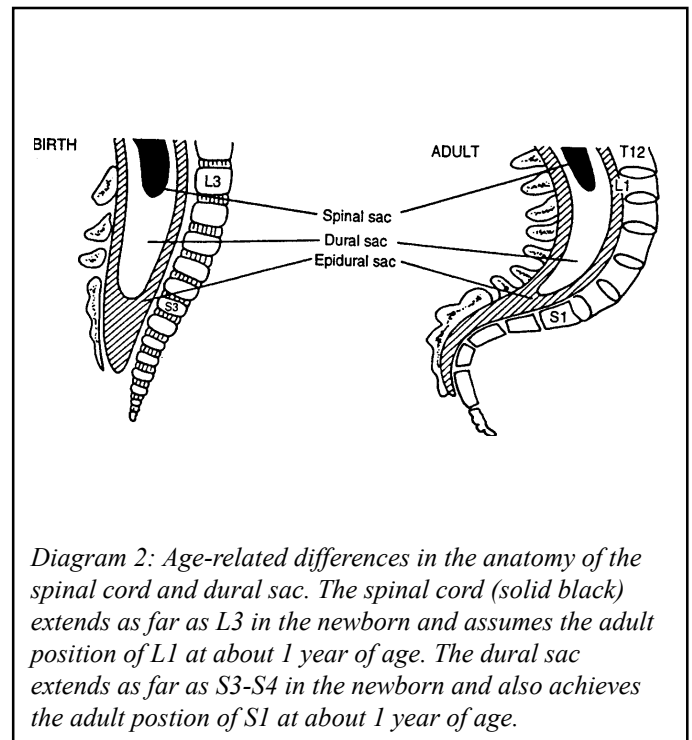

- c. **T** - Albumin levels in the child are low until about 1 year of age.
- d. **F** - The neonate depends on non-shivering thermogenesis, i.e. metabolism of brown fat. The latter is laid down from 22 weeks' gestation in the mediastinum, axillae, base of the neck and between the scapulae. Shivering does not occur until 3 months of age.
- e. **T** - Increased chest wall compliance allows it to be pulled inwards by the lung, decreasing the FRC, which may be less than the closing capacity. This, accompanied by an increase in O₂ consumption, predisposes the neonate to rapid desaturation.

4. Obesity:

- a. **F** - BMI (Body mass index) = body weight (in kg) / height squared (m²)

BMI (kg/m ²)	
<25	normal
25-30	overweight
30-35	obese
>35	morbidly obese

Mortality & morbidity rise sharply when the BMI exceeds 30kg/m².

Ref: Adams JP, Murphy PG. Obesity in anaesthesia and intensive care. British Journal of Anaesthesia 2000; 85: 91-108

- b. **T** - O₂ consumption & CO₂ production are increased due to the metabolic activity of adipose tissue & the increased workload on supportive tissues. FRC decreases because of reduced chest wall & lung compliance while closing capacity increases, adding to V/Q mismatch that is worsened in the supine position. This leads to impaired gas exchange & hypoxia. Possible sequelae include pulmonary vasoconstriction, pulmonary hypertension, right ventricular hypertrophy & failure. All these factors, coupled with the increased incidence of difficult intubation, predispose the obese patient to the risk of hypoxia on induction, during maintenance & after anaesthesia.
- c. **F** - Too small a cuff tends to over-estimate the blood pressure. It may occasionally be necessary to opt for invasive arterial pressure monitoring in these patients.

Ref: Hutton P, Prys-Roberts C (Ed.). Monitoring in Anaesthesia and Intensive Care. 1994. WB Saunders Company Ltd

- d. **F** - Intramuscular injections may be unpredictable & less effective than intravenous injections in these patients. PCA, if available, is a good option. If intravenous opioids are used small, titrated doses may be given but good nursing observation is required. Regional

blocks supplemented by oral NSAIDs or paracetamol are very useful, but may be more difficult to perform.

- e. **T** - The incidence is high due to prolonged immobility with venous stasis, raised haematocrit, cardiac failure, reduced fibrinolysis following surgery, and pressure of the increased weight of the abdomen on deep veins. DVT prophylaxis is essential.

5. Physiological response to surgery: Surgery is a form of trauma that causes a stress response characterised by neuro-endocrine and inflammatory changes that are aimed at ensuring survival and promoting wound healing. It consists of a catabolic phase that lasts 5 (or more) days during which fuel production and delivery is increased, sodium and water are retained, and potassium is lost. This is followed by an anabolic phase in which a positive nitrogen balance allows for replacement of lost muscle, and fat stores are replenished. Anaesthetic agents and techniques may modify this stress response.

- a. **T** - Gluconeogenesis and glycogenolysis are increased by cortisol and catecholamines; insulin resistance also occurs.
- b. **F** - Protein catabolism is enhanced by cortisol.
- c. **T** - The sympathetic system, activated by

Table 1. Principal hormonal response to surgery

Endocrine gland	Hormones	Change in secretion
Anterior pituitary	ACTH	Increases
	Growth hormone	Increases
	TSH	May increase or decrease
	FSH and LH	May increase or decrease
Posterior pituitary	ADH	Increases
Adrenal cortex	Cortisol	Increases
	Aldosterone	Increases
Pancreas	Insulin	Often decreases
	Glucagon	Usually small increases
Thyroid	Thyroxine, tri-iodothyronine	Decrease

the hypothalamus, causes increased adrenal catecholamine secretion and noradrenaline release from adrenergic neurons.

- d. **F** - ADH secretion is increased.
- e. **T** - Fibrinogen is an acute phase protein.

Ref: Desborough JP. The stress response to trauma and surgery. British Journal of Anaesthesia 2000; 85: 109-117

6. Thiopentone:

- a. **T** - Although the mode of action is unclear, GABA A receptors do have a role in the action of barbiturates, benzodiazepines, propofol and etomidate on the CNS. Barbiturates bind to distinct sites on the GABA A receptor and facilitate their response to GABA. GABA receptor activation increases chloride conductance, hyperpolarizes post-synaptic membranes and thereby reduces neuronal excitability.
- b. **T** - It should be used with caution in patients who are likely to be sensitive to its hypotensive effects (e.g. hypovolaemia, myocardial disease, valve stenosis), and patients with reduced protein binding resulting in raised free drug levels (e.g. hepatic or renal disease, burns, the elderly, advanced malignancies)
- c. **T** - It also reduces cerebral blood flow and intracranial pressure. It can reduce cerebral O₂ consumption by up to 50%. The remaining O₂ is consumed during processes that are necessary to maintain the integrity of neuronal cells.
- d. **F** - Barbiturates induce ALA synthetase. Other drugs considered to be unsafe include etomidate, halothane, antihistamines, steroids, some NSAIDS, lignocaine, theophylline and pentazosine.

Ref: British National Formulary Sept 2000

- e. **F** - Thiopentone reduces intraocular pressure, while suxamethonium increases it slightly. The risk of aspiration and coughing should be balanced against the risk of raising intra-ocular pressure by using suxamethonium.

7. Ketamine:

- a. **T** - It is metabolised in the liver to several active metabolites. Norketamine has 20-30% of the activity of ketamine. The relative potencies of other metabolites have not yet been determined.
- b. **T** - Mean total clearance depends on hepatic blood flow. Halothane reduces hepatic flow.
- c. **T**
- d. **T** - It increases heart rate and blood pressure, thus increases myocardial oxygen demand.
- e. **T** - In children it has been used in a dose of 0.5mg/kg with a local anaesthetic.

Ref: Cook et al. Comparison of the effect of adrenaline, clonidine and ketamine on the duration of caudal analgesia produced by bupivacaine in children. British Journal of Anaesthesia 1995;75: 698-701

8. Volatile agents:

- a. **F** - Epileptiform EEG changes may occur particularly with hypocapnia, and may persist for several weeks. Seizures have been reported after enflurane anaesthesia therefore it is best avoided in epileptic patients.
- b. **F** - The extent of metabolism of volatile agents is as follows: halothane 20%, enflurane 2%, isoflurane 0.2%, desflurane 0.02%, sevoflurane 3-5%.
- c. **T** - There is little myocardial depression and blood pressure is maintained. Dysrhythmias are rare so the use of adrenaline is relatively safe. Ether also causes some bronchodilatation.
- d. **F** - Sevoflurane has a low blood-gas partition co-efficient (0.69 vs. 2.4 for halothane) making induction and recovery smooth and extremely rapid. The blood-gas partition co-efficients of the inhalational agents at 37°C are: N₂O 0.47, enflurane 1.9, isoflurane 1.4, desflurane 0.42, and ether 12.
- e. **T** - Since its boiling point is close to room temperature, standard vaporisers are unsuitable. The Desflurane vaporiser is electrically powered, heating it to 39°C.

Fresh gas does not enter the vapourisation chamber. Instead, vapour (0-18%) is added to the fresh gas flow at the vaporiser outlet.

9. Drug interactions:

- a. **T** - Enhanced sedative effect
- b. **T** - Antibiotics that increase the plasma theophylline levels by inhibiting hepatic metabolism are erythromycin, clarithromycin, ciprofloxacin, and norfloxacin. Rifampicin decreases the levels.
- c. **T** - The effect of non-depolarising neuromuscular blocking drugs is enhanced by the following antimicrobials: aminoglycosides, clindamycin, colistin and piperacillin.
- d. **T** - There is a risk of severe hypotension, cardiac failure or asystole.
- e. **T** - Arrhythmias may occur if adrenaline or isoprenaline are used with halothane.

10. Blood transfusions:

- a. **T**
- b. **T**
- c. **F**
- d. **F**
- e. **T**

Infections that may be transmitted by blood transfusion are:

- Viral - Hepatitis B & C, HIV, HTLV-1, CMV, EBV
- Bacterial - contaminants during collection and storage (e.g. Pseudomonas, coliforms), syphilis, brucellosis, yaws
- Parasitic - malaria, trypanosomiasis, leishmaniasis.

The risk of transfusion-related infections can be reduced by screening donors and blood products, by using autologous blood, and by decreasing the amount of blood transfused. This can be achieved using the following strategies: accepting lower haemoglobin levels in healthy patients, pre-operative haemodilution, minimising intra-operative blood loss, and intra- and postoperative blood salvage. In addition, large blood transfusions may cause the following adverse effects:

- Coagulopathy due to reduced platelets, fibrinogen and factors V and VIII. Platelet and FFP administration should be guided

by the platelet count, fibrinogen level and INR.

- Impaired oxygen delivery to tissues because of the left shift of the ODC in stored blood (up to 24 hours).
- Hyperkalaemia - rarely a problem except in patients with pre-existing hyperkalaemia, acidosis, hypothermia or in children. Potassium rapidly re-enters red blood cells after infusion and warming.
- Hypocalcaemia - following rapid transfusion.
- Acid-base imbalance - transfused blood has a low pH and may initially cause a metabolic acidosis. Alkalosis may follow the metabolism of citrate to bicarbonate. Citrate intoxication may result from rapid transfusion. A warm, well-oxygenated adult can metabolise the citrate content of one unit of CPD blood in 5 minutes. Rapid infusion may exceed the metabolic rate, causing tremors, arrhythmias, acidosis and hypocalcaemia.
- Hypothermia - therefore blood should be warmed. Rapid transfusion of cold blood may cause cardiac arrest.

A massive blood transfusion is defined as the replacement of the total blood volume with transfused blood within 24 hours, or the transfusion of more than 5 units of blood within 1 hour.

11. Neuromuscular blockade:

- a. **T** - *see below*
- b. **F** - *see below*
- c. **F** - competitive antagonists
- d. **F** - volatile agents potentiate neuromuscular blockade
- e. **F** - fasciculations are characteristic of depolarising neuromuscular blocking drugs.

Neuromuscular blockade (NMB) can be monitored by assessment of a muscle's mechanical response to peripheral nerve stimulation. When a supramaximal stimulus (20-60mA) is applied to a peripheral nerve, avoiding direct stimulation of the muscle, the response obtained allows differentiation between depolarising and non-depolarising blockade.

Train of four (TOF) involves four 0.2msec stimuli at 2 Hz while double burst stimulation (DBS) consists of two 50Hz tetanic stimuli of 40msec separated by a 750msec interval. Non-depolarising block is characterised by fade on testing with TOF or DBS (mechanical twitch in response to first stimulus is greater than that due to subsequent stimuli). Non-depolarising block is also characterised by post-tetanic facilitation (following a tetanic stimulus of 50Hz for 5 seconds a subsequent TOF response is increased).

Ref: Hutton P and Prys-Roberts (Ed.) Monitoring in Anaesthesia and Intensive Care. 1994. WB Saunders Company Ltd.

12. Pulse oximetry:

- a. T
- b. F
- c. F
- d. T
- e. T

The pulse oximeter is a non-invasive device used to determine arterial oxygen saturation. The probe consists of two light-emitting diodes emitting red (660nm) and infrared (940nm) light on one side, and a photodetector on the other. Oxy- and deoxyhaemoglobin absorb light at different wavelengths. Comparison of the absorbance at the two different wavelengths enables the oximeter to calculate oxygen saturation. The pulsatile nature of arterial blood flow allows the oximeter to differentiate it from venous blood.

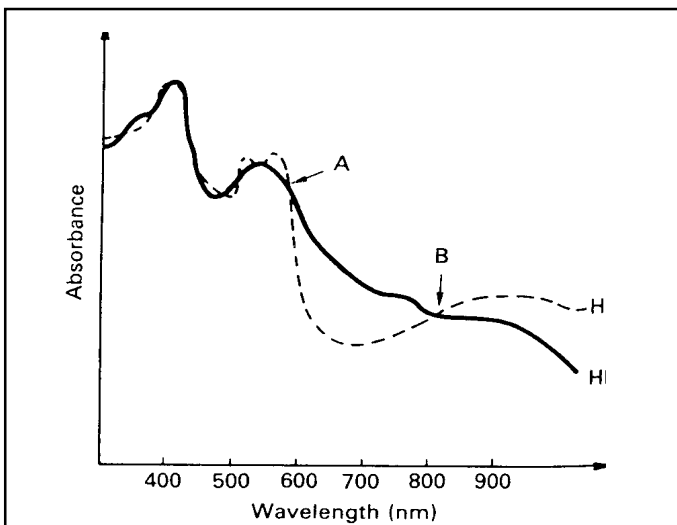

Diagram 3: Absorbance of light by oxygenated (HbO) and deoxygenated (Hb) haemoglobin. A and B are isobestic points.

It is accurate in the 70-100% range. Machine calibration is done on healthy volunteers so that below 70%, saturation readings are, by necessity, extrapolated. Inaccuracies result from carbon monoxide (gives falsely high values), methaemoglobinaemia (reads 85% regardless of true saturation), coloured nail varnish, IV dyes (e.g. methylene blue), vasoconstriction, excessive movement, venous pulsation, and interference from external fluorescent light.

The Beer-Lambert law forms the basis of spectrophotometric techniques such as oximetry. It is a combination of two laws that describe the absorption of monochromatic light by a transparent substance through which it passes.

- Beer's law: intensity of transmitted light decreases exponentially as the concentration of the substance increases.
- Lambert's law: intensity of transmitted light decreases exponentially as distance travelled through the substance increases.

13. Breathing systems:

- a. F - Lack = co-axial A; Bain = co-axial D.
- b. F - It requires a FGF equal to minute ventilation. It is inefficient for controlled ventilation when FGF = 2,5-3 times the minute volume.
- c. F - Mapleson E.
- d. T - This is a reason for its popularity in paediatric anaesthesia.
- e. F - The minimum flow rate that can be used is a flow rate of 100% oxygen that matches the total O₂ consumption of the patient (as low as 200-300ml O₂/min, depending on metabolic demands). This is only achievable after an initial period of high flow that adequately denitrogenates the patient and delivers volatile anaesthetic at a high enough rate during the initial period of high uptake.

14. The rotameter:

- a. T
- b. F
- c. F
- d. T
- e. F

The Rotameter is a constant pressure, variable orifice flowmeter. Inflow occurs via a needle valve into a tapered glass tube, which widens toward the top. When gas flows, a light metal bobbin floats on the gas jet, the height of the bobbin in the calibrated tube indicating the flow rate. At low flow rates, flow is a function of gas viscosity since the relatively longer and narrower annulus behaves like a tube allowing laminar flow. The Hagen-Poiseuille equation can be applied to calculate flow through a tube:

$$Q = \frac{\pi Pr^4}{8\eta l}$$

where Q = flow through a tube
 P = pressure across the tube
 r = radius
 l = length
 η = viscosity of the gas.

At high flow rates where the short wide annulus acts like an orifice, flow is turbulent. Here gas density is an important determinant of flow.

Each rotameter is accurately calibrated at specific pressure and temperature for its particular gas. Temperature changes encountered in clinical practice, however, have insignificant effects on accuracy of flow measurement.

Inaccuracies may result when the bobbin sticks against the tube because of tilting, static or dirt. Ensuring that the tube is vertical, clean & treated with an antistatic (a thin gold coating or an antistatic spray) will prevent errors in measurement.

15. Obstetric anaesthesia:

- a. **F** - A sensory block from T4-6 to S5 is required for adequate analgesia during Caesarean Section. Testing the sacral dermatomes is especially important with an epidural, as these nerve roots are not always blocked. This almost never happens with a spinal anaesthetic.
- b. **T** - Sodium citrate is non-particulate. Particulate antacids, if aspirated, may cause pneumonitis. In addition, they do not mix effectively with gastric contents.
- c. **T** - Factors contributing to the greater risk of hypoxaemia are the reduced FRC and

increased oxygen consumption in pregnancy, and the higher incidence of difficult intubation in this group of patients.

- d. **T** - The incidence of post-dural puncture headache (PDPH) is increased when large gauge spinal needles are used, especially if the longitudinal dural fibres are cut transversely by the needle bevel (as with a Quincke point). Pencil point needles split the fibres longitudinally, reducing the risk of a CSF leak. The incidence of PDPH is <1% with 25-29G pencil point needles (e.g. Whitacre or Sprotte).
- e. **T**

16. Regional anaesthesia:

- a. **F**
- b. **F** - While intravenous regional anaesthesia is relatively simple, the technique may be extremely hazardous if caution is not exercised. Measures to ensure safety include: siting a second intravenous cannula in a limb other than the operation site; use of an anaesthetic agent considered to be safe for IVRA (e.g. prilocaine, up to 5mg/kg without adrenaline; bupivacaine is contra-indicated for this purpose); use of a double cuffed tourniquet which has been checked for integrity; injecting the drug slowly so as to avoid exceeding the pressure in the tourniquet; not releasing the tourniquet before at least 20 minutes have elapsed since time of injection.
- c. **T** - Complications of brachial plexus blocks *see table below*
- d. **T** - Regional anaesthesia for the lower limb:
 The lumbar plexus originates from the primary ventral rami of L1-4 ± a contribution from T12. It lies between the quadratus lumborum and psoas muscles. It may be blocked by either an approach from the groin (3-in-1 block) or a posterior approach (lumbar plexus block).
- e. **T** - Neuraxial opioids:
 Opioids were first used clinically by the epidural and intrathecal routes in 1979. Their advantage over local anaesthetic given by these routes is that

they produce analgesia without affecting sensory, motor and autonomic function. They bind to opioid receptors in the spinal cord and periaqueductal grey matter of the midbrain, and produce analgesia by inhibiting pain pathways in the dorsal horn of the spinal cord and by stimulating descending inhibitory neuronal pathways. (Gate theory of pain, Melzack & Wall). They are used mainly in combination with local anaesthetics for both intraoperative postoperative analgesia. The combination may result in better analgesia of longer duration than local anaesthetics alone, and because a lower dose of local anaesthetic is used, there may be less motor block and hypotension. The required dose, onset and duration of action, and side effects of spinally administered opioids will depend on their lipid-solubility, molecular weight and shape, degree of ionisation, and the epidural blood flow. These factors affect dural and spinal cord permeability and the systemic absorption of the drugs via epidural veins. Unfortunately, complications of spinally administered opioids include respiratory depression, nausea and vomiting, pruritis (itching) and urinary retention. Pruritis is common after epidural (8.5%) and intrathecal (46%) opioids and may be treated with systemic antihistamines or naloxone.

Ref: Ballantyne et al. Pain 1988;33:149-160

17. Hepatitis and HIV:

- a. **F** - The risk of transmission of HIV is 0.3-0.5% whereas that for HBV is 30%
- b. **F** - Boosters are required every 5 years
- c. **T** - HBV and HIV are killed by autoclaving, ionising radiation, hypochlorite, formaldehyde, and gluteraldehyde
- d. **T** - Abdominal symptoms occur in 20-30% of HIV patients, and the diagnosis of acute abdomen may be difficult. Conditions that may present include GI perforation or obstruction, cholecystitis, acute appendicitis (twice as common), anorectal disease and haemorrhage
- e. **T** - HIV may cause a lymphocytic myocarditis. In advanced AIDS it may be caused by Cryptococcus, toxoplasmosis, Coxackie B, CMV, Nocardia, Aspergillus, and lymphoma.

18. Difficult intubation:

- a. **F**
- b. **T**
- c. **T**
- d. **T**
- e. **T**

Failure to intubate is relatively uncommon but an accurate preoperative assessment of the likely difficulty is obviously very important. Tests that may be used preoperatively include:

- 1. The Mallampati test: Class 1 = easy, class 4 = difficult. It will predict only 50% of difficult intubations.
- 2. Thyromental distance >6.5cm = easy (Patil)

Table - Complications of brachial plexus block

	Interscalene	Supraclavicular	Axillary
Phrenic nerve block	+	+	-
Recurrent laryngeal nerve block	+	+	-
Horner's syndrome	+	+	-
Extradural/intrathecal injection	+	-	-
Intravascular injection	Vertebral artery	Subclavian vessels	Axillary vessels
Pneumothorax	-	++	-
Nerve damage	+	+	+

3. Wilson et al devised a more complex scoring system based on body weight, extent of head, neck & jaw movement, and presence of receding mandible and prominent teeth.

19. Neck anatomy:

- F** - The cricoid cartilage is palpable at C6 and the thyroid cartilage at C4-5
- T**
- F**
- F** - It bifurcates at the level of C3
- F** - The artery passes posterior to the scalenus anterior muscle.

20. Tension pneumothorax:

- T** - but it is less likely than with the subclavian approach
- F** - It is a clinical diagnosis. It is a medical emergency, and treatment (i.e. needle decompression in 2nd intercostal space, mid-clavicular line) is required before a chest X-ray is taken
- T** - away from the side of the pneumothorax
- F** - IPPV will increase tension. The large bore needle (as above) is left in place until an intercostal drain has been inserted

- T** - It must be considered as one of the causes of pulseless electrical activity (or EMD = electromechanical dissociation). The causes to be excluded are
 - Hypoxia
 - Hypovolaemia
 - Hypothermia
 - Hyper- or hypokalaemia or metabolic disorders
 - Tension pneumothorax
 - Tamponade
 - Toxic or therapeutic disturbances
 - Thromboembolic/mechanical obstruction.

Clinical Scenario - answer

Problems: Hypovolaemia, full stomach as a result of swallowed blood, and difficulties with intubation due to presence of blood and oedema in the upper airway.

Assessment and resuscitation: assess airway, breathing and circulation, and resuscitate as necessary. Signs of blood loss include slow capillary refill, pallor, and a rapid, low volume pulse. Restlessness, confusion and a low blood pressure are late signs. It is easy to underestimate blood loss because large amounts may have been swallowed. Blood should be cross-matched and a full blood count and coagulation screen performed. Fluid replacement should be undertaken with crystalloid, colloid or blood, depending on how much blood has been lost. Hypovolaemia should be corrected before induction of anaesthesia because of the risk of cardiovascular collapse. The anaesthetic chart from the previous procedure should provide the rest of the information necessary to complete the anaesthetic assessment; difficulty with intubation and the size of the ET tube should be noted.

Preparation of the operating theatre. Two suction devices capable of removing blood clots (one may block when it is most needed), spare laryngoscopes (bulbs may become covered in blood) and tracheal tubes in a range of sizes (post operative oedema may reduce the size of the airway).

Anaesthetic technique. The commonest technique used is probably a rapid sequence induction using an intravenous induction agent and suxamethonium with pre-oxygenation and cricoid pressure. This technique may not be appropriate if proper pre-oxygenation is impossible (brisk bleeding or uncooperative patient)

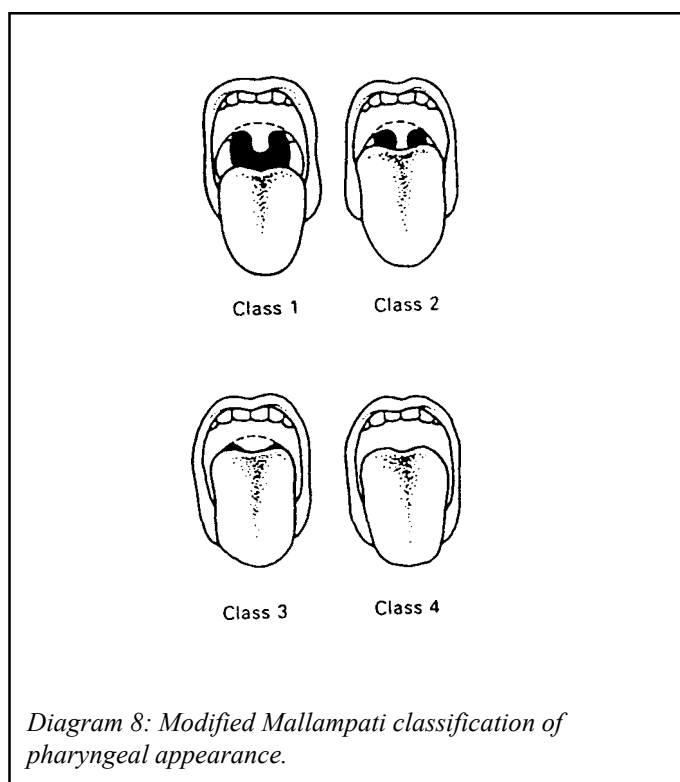

or if difficulty was experienced in intubating the patient for the original procedure (the presence of blood and oedema will certainly make it more difficult now!)

An alternative technique is a gaseous induction with the patient in the lateral position.

Because of the potential hypovolaemia, maintenance of anaesthesia is probably best achieved with a low concentration of volatile anaesthetic, muscle relaxation and IPPV.

Further fluids and blood should be transfused as necessary. An orogastric tube should be used to empty the stomach before extubation, and extubation should be performed in the lateral position with the child fully awake.

C. Answer to chest Xray

1. The first x-ray shows widespread opacification of the right hemithorax due to a pleural effusion. The mediastinum is shifted to the left. The second x-ray, taken after aspiration of the effusion, shows a large mediastinal mass and some residual pleural fluid. In this case it was an aggressive lymphoma.
2. These patients commonly present for minor procedures to establish a tissue diagnosis (e.g. lymph node biopsy). Tumours in this region may compress the tracheobronchial tree, the main pulmonary artery, the atria, or the superior vena cava, and can cause life-threatening complications during anaesthesia.

Large pleural effusions should be drained prior to anaesthesia. Symptoms of shortness of breath, an inability to lie flat or stridor indicate large airway compression. Induction of anaesthesia may be associated with complete airway obstruction. This is particularly associated with the loss of spontaneous ventilation. Intubation may be difficult because of compression and distortion of the trachea. Distended veins in the upper half of the body, oedema of the head and neck, collateral vessels in the chest wall and cyanosis are signs of superior vena caval obstruction. Respiratory symptoms may be due to engorged veins in the airway and mucosal oedema. A decreased level of consciousness may be due to cerebral oedema (venous hypertension). These patients often have an airway that is difficult to manage and intraoperative

bleeding can be a major problem. A CT scan of the chest should be performed. This will demonstrate any compression of vital structures. Additionally, flow/volume loops and echocardiography may be useful.

Because of the potential complications of general anaesthesia, these patients should always have procedures performed under local anaesthesia if possible. If this is not possible and the patient is symptomatic or if compression is demonstrated on the CT scan, consideration should be given to using radiotherapy or chemotherapy to shrink the tumour before a tissue diagnosis is obtained. If general anaesthesia is unavoidable, the following strategies should be considered.

Tracheobronchial compression:

- Awake intubation.
- Maintenance of spontaneous ventilation.
- Extreme caution with muscle relaxants.
- Ability to change the patient's position (obstruction may be less in the prone or lateral positions).
- Availability of a rigid bronchoscope to bypass the obstruction.
- ? Availability of cardiopulmonary bypass if the airway is lost completely.

Compression of the pulmonary artery and heart:

- Be able to change patient position.
- Maintain preload.
- Avoid negative inotropes. Ketamine may be a suitable agent.
- Have cardiopulmonary bypass available.

SVC obstruction:

- Head-up position to reduce swelling.
- IV lines in lower extremity.
- Treat the airway with caution (oedema, and potential for bleeding from minor trauma).
- Cross-match blood for even minor procedures,

Ref: Miller RD. Anaesthesia. 5th Ed. 2000. Churchill-Livingstone)

D. Answer to ECG:

1. Atrial fibrillation / flutter
RBBB
Left axis deviation (possibly L anterior hemiblock)
2. Complete heart block with ventricular escape.

EPIDURAL ANAESTHESIA

Dr Leon Visser, Dept. of Anesthesiology, University of Michigan Medical Center, Ann Arbor, Michigan, USA

INTRODUCTION

Epidural anaesthesia is a central neuraxial block technique with many applications. The epidural space was first described by Corning in 1901, and Fidel Pages first used epidural anaesthesia in humans in 1921. In 1945 Tuohy introduced the needle which is still most commonly used for epidural anaesthesia. Improvements in equipment, drugs and technique have made it a popular and versatile anaesthetic technique, with applications in surgery, obstetrics and pain control. Both single injection and catheter techniques can be used. Its versatility means it can be used as an anaesthetic, as an analgesic adjuvant to general anaesthesia, and for postoperative analgesia in procedures involving the lower limbs, perineum, pelvis, abdomen and thorax.

INDICATIONS

General

Epidural anaesthesia can be used as sole anaesthetic for procedures involving the lower limbs, pelvis, perineum and lower abdomen. It is possible to perform upper abdominal and thoracic procedures under epidural anaesthesia alone, but the height of block required, with its attendant side effects, make it difficult to avoid significant patient discomfort and risk. The advantage of epidural over spinal anaesthesia is the ability to maintain continuous anaesthesia after placement of an epidural catheter, thus making it suitable for procedures of long duration. This feature also enables the use of this technique into the postoperative period for analgesia, using lower concentrations of local anaesthetic drugs or in combination with different agents.

Specific uses

- **Hip and knee surgery.** Internal fixation of a fractured hip is associated with less blood loss when central neuraxial block is used. The rate of deep venous thrombosis is reduced in patients undergoing total hip and knee replacement, when epidural anaesthesia is used.
- **Vascular reconstruction of the lower limbs.** Epidural anaesthesia improves distal blood flow in

patients undergoing arterial reconstruction surgery.

- **Amputation.** Patients given epidural anaesthesia 48-72 hours prior to lower limb amputation may have a lower incidence of phantom limb pain following surgery, although this has not been substantiated.
- **Obstetrics.** Epidural analgesia is indicated in obstetric patients in difficult or high-risk labour, e.g. breech, twin pregnancy, pre-eclampsia and prolonged labour. Furthermore, Caesarean section performed under central neuraxial block is associated with a lower maternal mortality owing to anaesthetic factors than under general anaesthetic.
- **Low concentration local anaesthetics, opioids, or combinations of both** are effective in the control of postoperative pain in patients undergoing abdominal and thoracic procedures. Epidural analgesia has been shown to minimise the effects of surgery on cardiopulmonary reserve, i.e. diaphragmatic splinting and the inability to cough adequately, in patients with compromised respiratory function, such as those with chronic obstructive airway disease, morbid obesity and in the elderly. Epidural analgesia allows earlier mobilization, reduces the risk of deep venous thrombosis, and allows better cooperation with chest physiotherapy, preventing chest infections.
- **Thoracic trauma with rib or sternum fractures.** Adequate analgesia in patients with thoracic trauma improves respiratory function by allowing the patient to breathe adequately, cough and cooperate with chest physiotherapy.

CONTRAINDICATIONS

Absolute

- **Patient refusal**
- **Coagulopathy.** Insertion of an epidural needle or catheter into the epidural space may cause traumatic bleeding into the epidural space. Clotting abnormalities may lead to the development of a large haematoma leading to spinal cord compression.
- **Therapeutic anticoagulation.** As above
- **Skin infection at injection site.** Insertion of the

epidural needle through an area of skin infection may introduce pathogenic bacteria into the epidural space, leading to serious complications such as meningitis or epidural abscess.

- **Raised intracranial pressure.** Accidental dural puncture in a patient with raised ICP may lead to brainstem herniation (coning).

- **Hypovolaemia.** The sympathetic blockade produced by epidurals, in combination with uncorrected hypovolaemia, may cause profound circulatory collapse.

Relative

- **Uncooperative patients** may be impossible to position correctly, and be unable to remain still enough to safely insert an epidural.

- **Pre-existing neurological disorders**, such as multiple sclerosis, may be a contraindication, because any new neurological symptoms may be ascribed to the epidural.

- **Fixed cardiac output states.** Probably relative rather than absolute. This includes aortic stenosis, hypertrophic obstructive cardiomyopathy (HOCM), mitral stenosis and complete heart block. Patients with these cardiovascular abnormalities are unable to increase their cardiac output in response to the peripheral vasodilatation caused by epidural blockade, and may develop profound circulatory collapse which is very difficult to treat.

- **Anatomical abnormalities of vertebral column** may make the placement of an epidural technically impossible.

- **Prophylactic low dose heparin** (see discussion below)

EPIDURALS AND ANTICOAGULANTS

(see also page 7)

- Full oral anticoagulation with warfarin or standard heparin (SH) are absolute contraindications to epidural blockade.

- Partial anticoagulation with low molecular weight heparin (LMWH) or low dose warfarin (INR <1.5) are relative contraindications.

- Minihep (low dose standard heparin (SH), 5,000units bd s/c is not associated with an increased risk of epidural haematoma. Wait for 4 hours after a

dose before performing epidural. Minihep/SH should not be given until 1 hour following epidural injection. These guidelines also apply for removal of epidural catheters.

- LMWH (<40mg enoxaparin and dalteparin): allow 12hr interval between LMWH administration and epidural; this also applies to removal of epidural catheters.

- NSAID's (including aspirin) do not increase the risk of epidural haematoma.

- Intraoperative anticoagulation using 5000units i/v heparin following epidural/spinal injection appears safe, but careful postoperative observations are recommended. Bloody tap or blood in epidural catheter is controversial. Some teams delay surgery for 12hr, others (if pre-op coagulation normal) delay i/v bolus of heparin for 1hour.

- Fibrinolytic and thrombolytic drugs: avoid epidural block for 24 hrs, check clotting prior to insertion.

- Thrombocytopenia: epidurals are relatively contraindicated below platelet count of 100,000/mm³.

- An epidural haematoma should be suspected in patients who complain of severe back pain a few hours/days following any central neuraxial block or with any prolonged or abnormal neurological deficit (including sensory loss, paraesthesiae, muscle weakness and disturbance of bladder control and anal sphincter tone). A high index of suspicion is required, with early orthopaedic or neurosurgical referral for decompression of the haematoma. Even with early recognition, the morbidity of this condition is still very high.

ANATOMY OF THE EPIDURAL SPACE (figure 1)

The epidural space is that part of the vertebral canal not occupied by the dura mater and its contents. It is a potential space that lies between the dura and the periosteum lining the inside of the vertebral canal. It extends from the foramen magnum to the sacral hiatus. The anterior and posterior nerve roots in their dural covering pass across this potential space to unite in the intervertebral foramen to form segmental nerves. The anterior border consists of the posterior longitudinal ligament covering the vertebral bodies, and the intervertebral discs. Laterally, the epidural

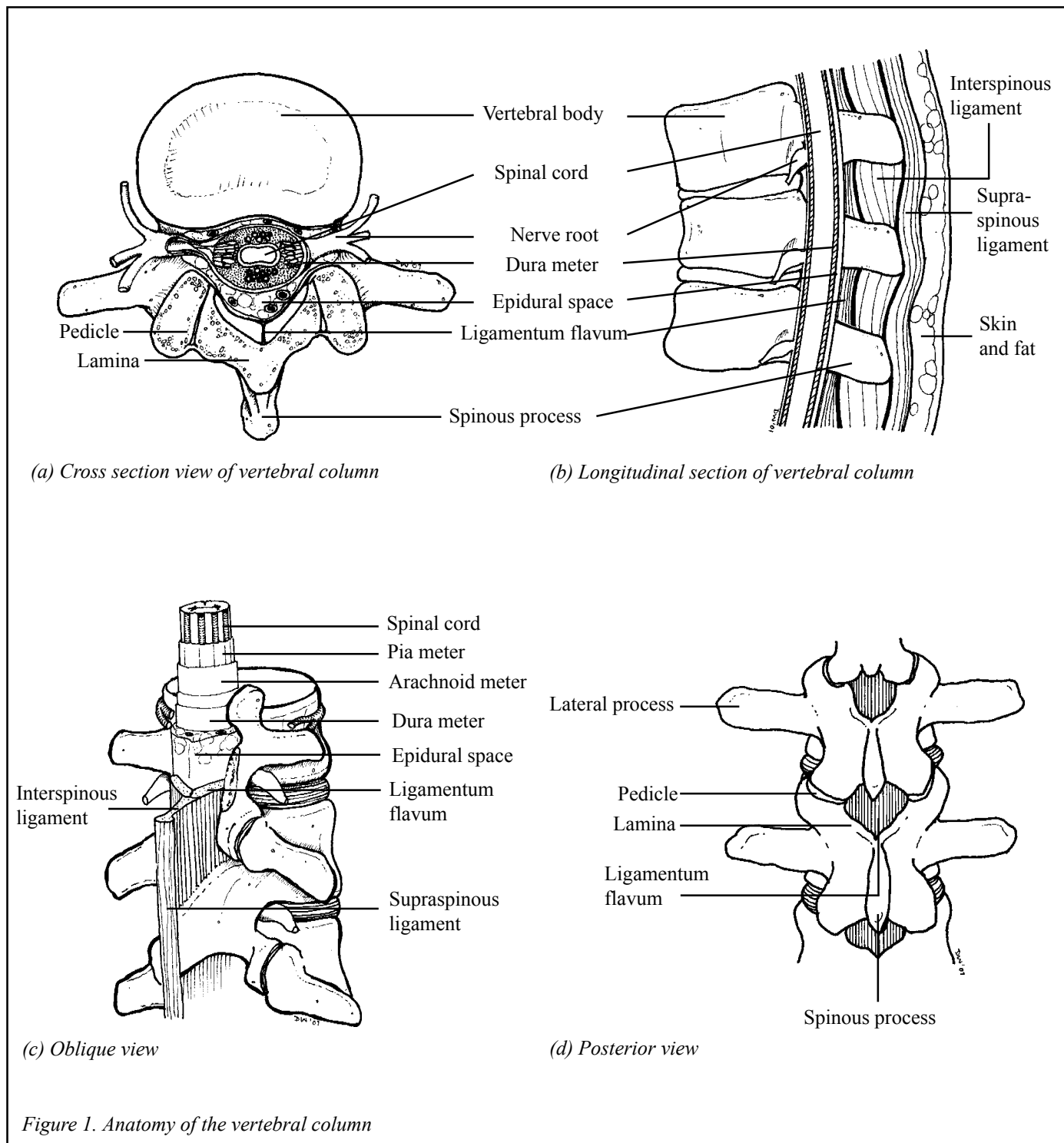

space is bordered by the periosteum of the vertebral pedicles, and the intervertebral foraminae. Posteriorly, the bordering structures are the periosteum of the anterior surface of the laminae and articular processes and their connecting ligaments, the periosteum of the root of the spines, and the interlaminar spaces filled by the ligamentum flavum. The space contains venous plexuses and fatty tissue which is continuous with the fat in the paravertebral space.

TECHNIQUE OF EPIDURAL ANAESTHESIA

Preparation

An epidural must be performed in a work area that is equipped for airway management and resuscitation. Facilities for monitoring blood pressure and heart rate must be available. It is advisable to obtain informed consent prior to performing an epidural in the same way as before any other invasive procedure. The patient should be informed of the possible risks and

complications associated with epidurals (see below). A formal pre-anaesthetic assessment should be carried out, and this should be no less rigorous than one carried out prior to general anaesthesia. Special attention should be given to the patient's cardiovascular status, with the emphasis on valvular lesions or other conditions that might impair the ability to increase cardiac output in response to the vasodilatation that inevitably follows sympathetic blockade. The back should be examined and any lesions or abnormalities noted. Laboratory assessment of the patient's coagulation status is necessary where there is any doubt regarding coagulopathy or anticoagulation therapy. INR (or prothrombin time), APTT and absolute platelet count should be within the normal range. Where there is doubt about platelet function in the presence of a normal platelet count, a haematologist's advice should be sought.

Prior to performing the block, all equipment should be checked. Intravenous access, preferably with a large bore cannula (e.g. 16G), is mandatory before the block is sited. The skin should be prepared with alcohol or iodine-containing sterilising solution. The back should be draped in a sterile fashion, and the operator should take full sterile precautions, including gown, mask and gloves.

Equipment

Modern epidural kits are usually disposable and packed in a sterile fashion. All equipment and drugs used should be sterile, and drugs should be preservative free.

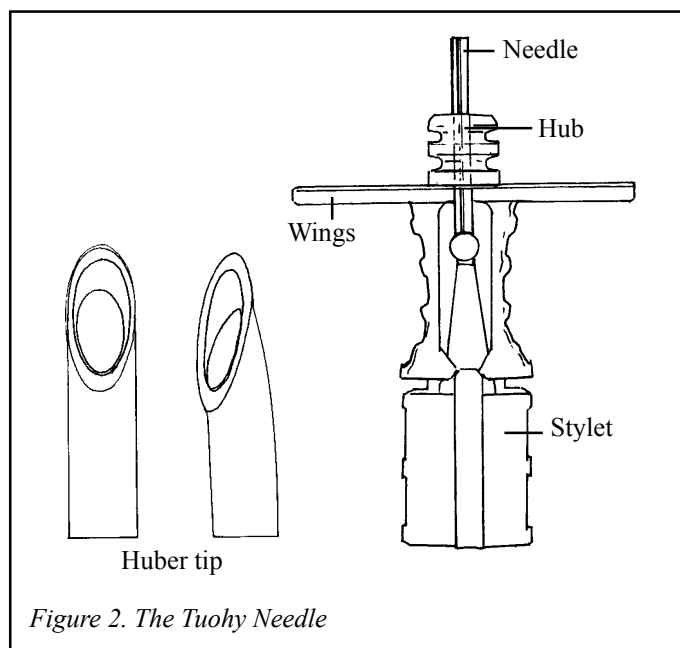

The epidural needle is typically 16-18G, 8cm long with surface markings at 1cm intervals, and has a blunt bevel with a 15-30 degree curve at the tip. The most commonly used version of this needle is the Tuohy needle, and the tip is referred to as the Huber tip. Most commercially available needles have the Tuohy/Huber configuration and have wings attached at the junction of the needle shaft with the hub, which allow better control of the needle as it is advanced. The original winged needle was called the Weiss needle (figure 2).

Traditionally, a glass syringe with a plunger, which slides very easily, has been used to identify the epidural space. Newer, commercially available disposable epidural packs contain a plastic syringe with a plunger that has very low resistance. Normal syringes should not be used because their greater resistance may make

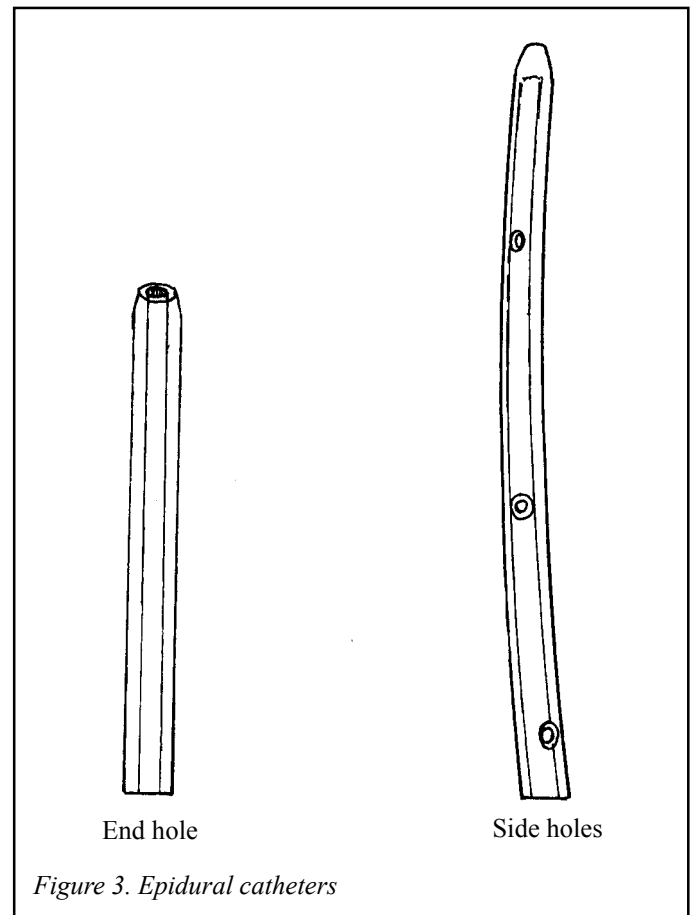

identification of the epidural space more difficult. Epidural catheters are designed to pass through the lumen of the needle and are made of a durable but flexible plastic, and have either a single end-hole or a number of side holes at the distal end (figure 3). A filter is attached via Luer-Lok to a connector, which, when tightened, grips the proximal end of the catheter,

and serves to prevent the inadvertent injection of particulate matter into the epidural space, and also acts as a bacterial filter. These filters are also usually included in disposable epidural packs.

Techniques to identify the epidural space

The epidural space is entered by the tip of the needle after it passes through the ligamentum flavum. The space is very narrow and is sometimes called a potential space, as the dura and the ligamentum flavum are usually closely adjacent. The space therefore has to be identified as the bevel of the needle exits the ligamentum flavum, as the dura will be penetrated shortly after if the needle is advanced any further. To identify this point, several techniques have been developed over the years, but currently most practitioners use a syringe to identify a loss of resistance when pressure is applied to the plunger. Some use saline in the syringe, and others use air. The two techniques are broadly similar, with some subtle differences in the way the syringe is advanced and the epidural space entered. Other techniques to identify the epidural space have been used in the past, e.g. the “hanging drop technique”. With this technique, a drop of saline is placed at the hub of the needle and the needle (without syringe) is advanced. The epidural space is identified when the drop is “sucked” into the needle by the negative atmospheric pressure in the epidural space (equivalent to the intrapleural pressure). This technique is rarely used today.

The block can be performed with the patient either in the sitting or lateral decubitus position. The patient should be encouraged to adopt a curled up position, as this tends to open the spaces between the spinous processes and facilitates the identification of the intervertebral spaces. After the back has been prepared with sterile solution and draped in sterile fashion, the desired level is selected (see below).

Midline approach (figure 4)

- Using local anaesthetic raise a subcutaneous wheal at the midpoint between two adjacent vertebrae. Infiltrate deeper in the midline and paraspinously to anaesthetise the posterior structures. At the planned puncture site make a small hole in the skin using a 19G needle.
- Insert epidural needle into the skin at this point, and advance through the supraspinous ligament, with

the needle pointing in a slightly cephalad direction. Then advance the needle into the interspinous ligament, which is encountered at a depth of 2-3 cm. until distinct sensation of increased resistance is felt as the needle passes into the ligamentum flavum (most people pass the needle through the interspinous ligament and into the ligamentum flavum before attaching the LOR syringe)

- At this point, remove the needle stylet and attach the syringe to the hub of the needle. If loss of resistance to saline is to be used fill the syringe with 5-10ml of normal saline. Hold the syringe in the right hand (for a right handed operator) with the thumb on the plunger. The left hand grips the wing of the needle between thumb and forefinger, while the dorsum of the left hand rests against the back. The left hand acts to steady the needle and to serve as a “brake” to prevent the needle from advancing in an uncontrolled way. Using the thumb of the right hand to exert constant pressure on

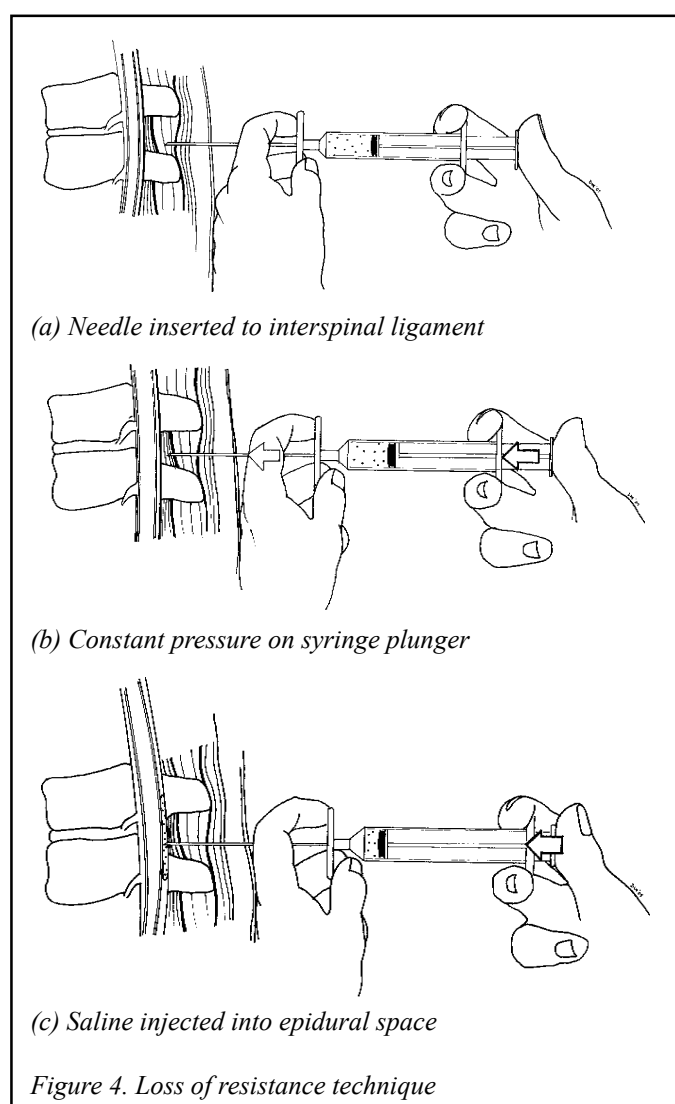

the plunger advance the needle through the interspinous ligament and then into the ligamentum flavum. While the tip of the needle is in the interspinous ligament there may be some loss of saline into the tissues as the tissue is not particularly dense, but there is usually significant resistance to pressure on the plunger. Occasionally, this false loss of resistance may cause some difficulty with placing an epidural. Once the needle enters the ligamentum flavum, there is usually a distinctive sensation of increased resistance, as this is a dense ligament with a leathery consistency. With continuous pressure on the plunger, advance the needle slowly until its tip exits the ligamentum flavum and the saline is easily injected into the epidural space, and the needle stops advancing.

- Remove the syringe and thread the catheter gently via the needle into the epidural space. The catheter has markings showing the distance from its tip, and should be advanced to 15-18cm at the hub of the needle, to ensure that a sufficient length of catheter has entered the epidural space. Remove the needle carefully, ensuring that the catheter is not drawn back with it. The markings on the needle will show the depth of the needle from the skin to the epidural space, and this distance will help determine the depth to which the catheter should be inserted at the skin. For example, if the needle entered the epidural space at a depth of 5cm, the catheter should be withdrawn so that the 10cm mark is at the skin, thus leaving approximately 5cm of the catheter inside the epidural space, which is an appropriate length.

- The technique when using loss of resistance to air is slightly different. With 5-10ml of air in the syringe, attach it to the hub of the needle once it has entered the interspinous ligament. Grip both wings of the needle between the thumb and forefinger of both hands. The plunger is gently pressed, and if there is resistance (“bounce”), the needle is very carefully advanced, with the dorsum of both hands resting against the back to provide stability. After 2-3mm, the plunger is again gently pressed, and this procedure is repeated as the needle is carefully advanced through the tissues. The distinctive increase in resistance when the needle enters the ligamentum flavum is felt, and the process is continued in 2mm increments. There is usually a distinctive “click” when the needle enters the epidural space, and provided great care is taken, and the needle only advanced in 2mm increments, the

needle should stop before it reaches the dura. At this point air can be injected into the epidural space very easily. The syringe is removed and the catheter threaded as above.

Paramedian approach

- Epidurals can be sited at any level along the lumbar and thoracic spine, enabling its use in procedures ranging from thoracic surgery to lower limb procedures. Due to the downward angulation of the spinous processes of the thoracic vertebrae,

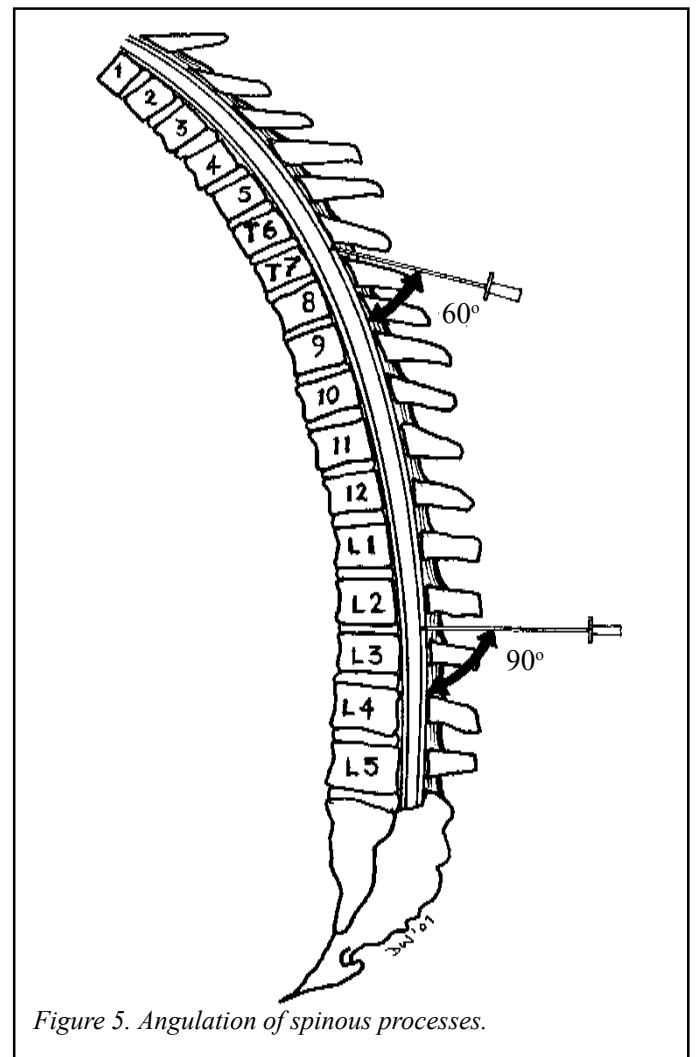

Figure 5. Angulation of spinous processes.

particularly in the mid-thoracic region, the needle has to be directed much more cephalad, to proceed through the ligamentous tissue and into the epidural space (figure 5). The ligaments in this area are also less dense and a false loss of resistance is not uncommon. Because of the oblique arrangement of the spinous processes, the needle has to travel a longer distance before reaching the ligamentum flavum, and there is less space between the spinous processes. It is therefore much more common to encounter bony resistance

during the placement of thoracic epidurals. For this reason, many practitioners prefer to use a paramedian approach in this region.

- Insert the needle, not in the midline in the space between the spinous processes, but 1-2cm lateral to the spinous process of the more cephalad vertebra.
- Advance the needle; perpendicular to the skin until the lamina or pedicle is encountered, and then redirect it approx 30° cephalad and 15° medially in an attempt to “walk the needle” off the lamina, at which point the

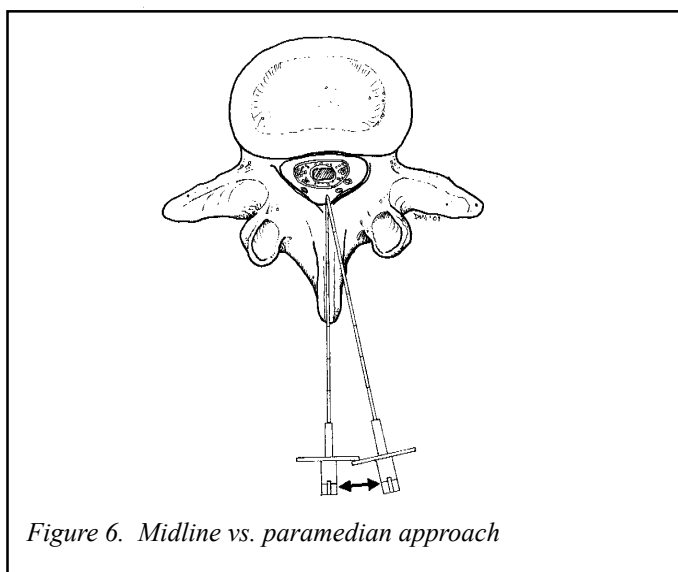

Figure 6. Midline vs. paramedian approach

needle should be in close proximity to the ligamentum flavum. The needle is then advanced further using a loss of resistance technique (figure 6).

Thoracic epidurals are technically more difficult to perform than lumbar epidurals, and should be attempted only once a practitioner is experienced and confident in the performance of lumbar epidural blocks.

Problem solving during performance of an epidural

- **Bony resistance everywhere** - try flexing more or changing position. If still unsuccessful, try paramedian approach (if using midline approach).
- **Unable to thread catheter** - try rotating the needle slightly so that the bevel changes direction. Most commercial epidural packs contain a catheter stabiliser, which attaches to the hub of the needle and may make feeding the catheter easier. If still unsuccessful, the needle is unlikely to be in the epidural space. Do not pull back the catheter through the needle as the tip may be cut off.

- **Fluid through needle** - if using saline, wait a few seconds to see if it stops flowing. If not, dural puncture is likely. Resite epidural at a different level. If fluid stops flowing, continue as before, but give small doses of local anaesthetic incrementally and observe carefully for signs of subarachnoid block.

- Fluid through catheter - *as above*

- **Pain on insertion of the catheter** - a brief sensation of “electric shock” on insertion of the catheter is not unusual, but if it persists, the needle or catheter may be up against a nerve root and should be withdrawn and resited.

- **Blood in catheter.** This indicates that the catheter has entered an epidural vein. Withdraw catheter by 1-2cm provided this will leave at least 2-3cm in the space and flush through with saline. Aspirate again to see if blood is still flowing through catheter. If blood has stopped, the catheter may be used, but with great care, making sure at all times that 1) catheter is aspirated prior to any subsequent doses of local anaesthetic 2) all doses are given in small increments 3) the patient is carefully monitored for any early signs of local anaesthetic toxicity.

FACTORS AFFECTING EPIDURAL ANAESTHESIA

Site of injection

- After lumbar injection, analgesia spreads both caudally and, to a greater extent, cranially, with a delay at the L5 and S1 segments, due to the large size of these nerve roots.

- After thoracic injection, analgesia spreads evenly from the site of injection. The upper thoracic and lower cervical roots are resistant to blockade due to their larger size. The epidural space in the thoracic region is usually smaller and a lower volume of local anaesthetic is needed.

Dosage

The dose required for analgesia or anaesthesia is determined by several factors but generally, 1-2ml of local anaesthetic is needed per segment to be blocked. The spread of local anaesthetic in the epidural space is unpredictable as the size of the epidural space is variable, as is the amount of local anaesthetic that leaks into the paravertebral space.

The dose (in milligrams) is a function of the volume injected and the concentration of the solution, and the response is not necessarily the same if the same dose is used but in a different volume and concentration. A higher volume of a low concentration of local anaesthetic will result in a larger number of segments blocked but with less dense sensory block and less motor block. It is important to remember that sympathetic nerve fibres have the smallest diameter and are most easily blocked (see below), even with low concentrations of local anaesthetic, and the degree of sympathetic block is related to the number of segments blocked. With an epidural catheter, incremental dosing is possible and this is important in preventing excessively high sympathetic block with hypotension.

The need for repeat or “top-up” doses of local anaesthetic is dependent on the duration of action of the drug. Repeat doses should be given before the block regresses to the extent that the patient experiences pain. A useful concept is the “time to two-segment regression”. This is the time from injection of the first dose of local anaesthetic to the point where maximum sensory level has receded by two segments. When two-segment regression has occurred, approximately one half of the original dose should be injected to maintain the block. The time to two-segment regression for lignocaine is 90-150 minutes, and for bupivacaine it is 200-260 minutes.

Age, height & weight

There is an age related decrease in the volume of local anaesthetic needed to achieve a given level of block, presumably due to a decrease in the size and compliance of the epidural space. The patient’s height appears to correlate to some extent with the volume of local anaesthetic needed, so that an adult of 5ft should receive a volume of local anaesthetic at the lower end of the range (i.e. 1ml per segment blocked), while volumes up to 2ml per segment may be required for taller patients. The safest approach is to inject incremental doses and monitor the effect carefully. There is little correlation between the weight of a patient and the volume of local anaesthetic needed, although in morbidly obese patients the epidural space may be compressed due to the effect on intra-abdominal pressure, and a smaller volume of local anaesthetic is needed. Furthermore, venous

engorgement of the epidural space due to compression of the azygos venous system may further reduce the volume of the epidural space, and increase the risk of puncture of an epidural vein. The same applies to patients with ascites, large intra-abdominal tumours and in the latter stages of pregnancy.

Posture

The effect of gravity during placement of the block has traditionally been assumed to have an effect on the spread of local anaesthetic and thus the area blocked, i.e. in the sitting position the lower lumbar and sacral roots are preferentially blocked, while in the lateral decubitus position, the nerve roots on the dependent side are more densely anaesthetised. Although there is very little scientific evidence that this is the case, the clinical experience of most practitioners suggests that gravity may have some effect.

Vasoconstrictors

Although the addition of vasoconstrictors to local anaesthetic drugs has been shown to prolong anaesthesia with other regional techniques and local infiltration, their effect on epidural anaesthesia is less consistent. With bupivacaine, the addition of adrenaline has not been shown to prolong anaesthesia, while with lignocaine; the addition of adrenaline (usually 1:200 000) does prolong the duration of action. However, vasoconstriction does reduce the amount of systemic absorption of local anaesthetic drugs, and reduces the risk of toxicity.

Alkalinisation of local anaesthetics

Commercially available solutions of local anaesthetics have a pH between 3.5 and 5.5, for chemical stability and bacteriostasis. Most local anaesthetics are weak bases and exist in their ionised (hydrophilic) form at this pH. Since nerve blockade is dependent on penetration of the lipid nerve cell membranes, and the non-ionised (lipophilic) form crosses membranes more easily, it follows that raising the pH of the solution will increase the proportion of drug in the non-ionised form and thus enhance nerve membrane penetration and speed up the onset of blockade. The addition of 8.4% sodium bicarbonate (0.5ml per 10ml of local anaesthetic solution) has become popular in achieving more rapid onset of blockade with, for example, emergency Caesarean Section.

PHYSIOLOGICAL EFFECTS OF EPIDURAL BLOCKADE

The segmental nerves in the thoracic and lumbar region contain somatic sensory, motor and autonomic (sympathetic) nerve fibres. Sensory and autonomic fibres have a smaller diameter and are more easily blocked than larger, more rapidly-conducting motor fibres. The relationship between sensory and autonomic outflow is complex, but sympathetic block usually extends 1-2 levels higher than sensory block.

Effects on organ systems

- **Cardiovascular system.** Vasodilatation of resistance and capacitance vessels occurs, causing relative hypovolaemia and tachycardia, with a resultant drop in blood pressure. This is exacerbated by blockade of the sympathetic nerve supply to the adrenal glands, preventing the release of catecholamines. If blockade is as high as T2, sympathetic supply to the heart (T2-5) is also interrupted and may lead to bradycardia. The overall result may be inadequate perfusion of vital organs and measures are required to restore the blood pressure and cardiac output, such as fluid administration and the use of vasoconstrictors. Sympathetic outflow extends from T1 - L2 and blockade of nerve roots below this level, as with, for example, knee surgery, is less likely to cause significant sympathetic blockade, compared with procedures requiring blockade above the umbilicus.

- **Respiratory system.** Usually unaffected unless blockade is high enough to affect intercostal muscle nerve supply (thoracic nerve roots) leading to reliance on diaphragmatic breathing alone. This is likely to cause distress to the patient, as they may feel unable to breathe adequately.

- **Gastrointestinal system.** Blockade of sympathetic outflow (T5-L1) to the GI tract leads to predominance of parasympathetic (vagus and sacral parasympathetic outflow), leading to active peristalsis and relaxed sphincters, and a small, contracted gut, which enhances surgical access. Splenic enlargement (2-3 fold) occurs.

- **Endocrine system.** Nerve supply to the adrenals is blocked leading to a reduction in the release of catecholamines.

- **Genitourinary tract.** Urinary retention is a common problem with epidural anaesthesia. A severe

drop in blood pressure may affect glomerular filtration in the kidney if sympathetic blockade extends high enough to cause significant vasodilatation.

- **Effects on cardiovascular physiology during pregnancy.** Aortocaval compression by the gravid uterus in the supine position leads to hypotension due to compression of the inferior vena cava, which results in diminished venous return and a drop in cardiac output. Epidural blockade, with its attendant sympathetic blockade, exacerbates the hypotension by causing peripheral vasodilatation. Compression of the aorta also reduces uterine blood flow, and it is thus clear that the combination of aortocaval compression and epidural blockade can have a profound effect on uterine and therefore placental blood flow. The supine position should be avoided in pregnant women undergoing epidural analgesia and anaesthesia, and the patient should be in a lateral (preferably left) or tilted position at all times. Hypotension should be corrected promptly with fluid replacement in the first instance. Alpha-adrenergic drugs, such as methoxamine or phenylephrine, have traditionally been avoided as they cause constriction of uterine vessels and may worsen uterine hypoperfusion. Ephedrine is the drug of choice, as it is primarily a β -agonist and increases blood pressure by increasing cardiac output. However, should profound hypotension occur, a pure vasoconstrictor may be more effective in raising the blood pressure and therefore the uterine perfusion pressure.

EPIDURAL MANAGEMENT AND CHOICE OF DRUGS

Single injection versus catheter techniques

Single shot epidurals, without the use of a catheter, is still widely used in various settings, and is effective in providing intraoperative anaesthesia and analgesia in the immediate postoperative period. The major disadvantages of single shot epidurals are 1) the duration of postoperative analgesia is limited to the duration of action of the drug given and cannot be topped up, and 2) the risk involved in injecting a full "anaesthetic" dose of local anaesthetic into the epidural space without a test dose and without the ability to give slow increments. This means that the risks of inadvertent high block, total spinal and local anaesthetic toxicity (see below) are much greater. For this reason it is difficult to justify the use of single

Examples of procedures, techniques and drug choice

	Labour analgesia	LSCS	Hip / knee surgery	Laparotomy under general anaesthetic	Thoracotomy or fractured ribs
Level of Insertion	L2-L4	L2-4	L2-4	T8-10	At relevant interspace – usually T5-7
Recommended height of block	T8-9	T6-7	T10	Upper abdo T7-8, lower abdo T10	Relevant area
Density of block	Minimal motor	Motor and sensory	Motor and sensory	Sensory + minimal motor	Sensory + minimal motor
Choice of Local Anaesthetic	0.1-0.25% bupivacaine	Lignocaine 2% + adrenaline 15-20mls or bupivacaine 0.5%	Bupivacaine 0.5%	Bupivacaine 0.25% -0.5% in theatre	Bupivacaine 0.25%- 0.5% in theatre or to establish block
Choice of Opioid	Fentanyl 50mcg	Fentanyl 100mcg	Morphine 1-2mg or diamorphine 2-3mg	Morphine 1-2mg or diamorphine 2-3mg	Morphine 1-2mg or diamorphine 2-3mg
Infusion	Bupivacaine 0.1% + fentanyl 2mcg/ml	Postoperative bupivacaine 0.166% + diamorphine 0.1mg/ml	Not usually necessary	Postoperative bupivacaine 0.166% + diamorphine 0.1mg/ml	Postoperative bupivacaine 0.166% + diamorphine 0.1mg/ml
Rate of infusion	0-12mls/hour	0-8mls/hour	-	0-12mls/hour	0-8mls/hour

Note: 0.166% bupivacaine is made by diluting 10mls of 0.5% with 20mls saline

shot techniques under any circumstances, and especially by inexperienced practitioners.

Once a catheter is placed, the filter and its connector are attached to the proximal end of the catheter. At this point, a test dose of local anaesthetic is injected to ensure that the catheter is not in fact in the subarachnoid space. A small dose, e.g. 0.5% bupivacaine 3.5ml, bearing in mind the volume of the filter, which is about 1ml, is injected and the response noted over the next few minutes. This dose, if injected into the subarachnoid space, will cause complete surgical anaesthesia below the level of injection, and will be accompanied by the drop in blood pressure usually seen in spinal anaesthesia. It is unlikely to cause significant sensory block or hypotension if correctly injected into the epidural space. Following the test dose, the procedure for the administration of further local anaesthetic will depend on the purpose of the epidural. The important principle is that any bolus

injection of local anaesthetic should be given incrementally, and the response carefully monitored, so that the practitioner can react promptly to any adverse reaction. Once a satisfactory block is established, whether for surgical anaesthesia, analgesia in labour or any other indication, the block can be maintained either by intermittent bolus administration of local anaesthetic (with or without opioids) or as a continuous infusion, if the necessary equipment is available.

Choice of drugs

The choice of drugs administered epidurally depends on the indication for the epidural:

- **Surgical anaesthesia** - requires dense sensory block and usually moderate to dense motor block. To achieve this, concentrated local anaesthetic preparations are required. The most commonly used local anaesthetics in this setting are 2% lignocaine 10-

20ml (with or without adrenaline 1:200 000) or 0.5% bupivacaine 10-20ml. The latter has a longer duration of action, but a slower onset time, compared with lignocaine.

- For analgesia during labour, 0.1-0.25% bupivacaine 5-10ml is more popular, as it produces less motor block

- Postoperative analgesia, weaker concentrations of bupivacaine, e.g. 0.1-0.166% with or without added low dose opioids, by bolus, continuous infusion or PCEA (patient controlled epidural analgesia) has been shown to be safe and efficient when given by via a syringe pump.

Opioids in the epidural space

The addition of opioids to local anaesthetic solutions has gained popularity; as the opioids have a synergistic effect by acting directly on opioid receptors in the spinal cord. Various opioids, such as morphine (2-5mg), fentanyl (50-100mcg) and diamorphine (2-4mg), have been used successfully both alone and in combination with local anaesthetic drugs, during labour, for intraoperative use and for postoperative analgesia. The combination of low-concentration local anaesthetic and low-concentration mixtures of opioids, administered by slow infusion rather than as intermittent boluses, has, in particular, been shown to be very effective in the management of postoperative pain.

The amount of opioid, e.g. diamorphine in the examples above, should be reduced where there is an increased risk of respiratory depression, i.e. the elderly, the very frail or in patients with significant chronic obstructive airway disease.

Caution should be exercised when morphine is administered epidurally, as it is associated with delayed respiratory depression. This is thought to be as a result of its low lipid solubility, which means that instead of binding to opioid receptors in the spinal cord, some of the drug remains in solution in the CSF, and the circulation of CSF transports the remaining drug to the brainstem where it acts on the respiratory centre. This may occur many hours (up to 24 hours) after morphine has been administered epidurally.

Opioids have also been used on their own in the epidural space. Pethidine (meperidine) 25-75mg, in particular, has a structure similar to local anaesthetics

and is effective in providing surgical anaesthesia and postoperative analgesia.

All opioids given by this route have the potential to cause respiratory depression, and this should be borne in mind when the patient is discharged from the care of the anaesthetist. Patients should be managed postoperatively in an area with a high nurse-to-patient ratio, and should be monitored carefully with special attention to their respiratory rate and level of consciousness. Epidural opioids should be avoided where there are inadequate resources for such careful monitoring. Other drugs used successfully via the epidural route include ketamine and alpha-2 receptor blockers such as clonidine.

COMPLICATIONS AND SIDE EFFECTS

Serious complications may occur with epidural anaesthesia. Facilities for resuscitation should always be available whenever epidural anaesthesia is performed.

Hypotension has been discussed and is the commonest side effect of successful therapeutic blockade for procedures above the umbilicus. It is especially common in pregnancy, both in labour and when used for Caesarean Section, and should be corrected promptly using fluid and vasopressors. The presenting symptom of hypotension is often nausea, which may occur before a change in blood pressure has even been detected.

Inadvertent high epidural block due to an excessively large dose of local anaesthetic in the epidural space may present with hypotension, nausea, sensory loss or paraesthesia of high thoracic or even cervical nerve roots (arms), or difficulty breathing due to blockade of nerve supply to the intercostal muscles. These symptoms can be very distressing to the patient and in the most severe cases may require induction of general anaesthesia with securing of the airway, while treating hypotension. If the patient has a clear airway and is breathing adequately they should be reassured and any hypotension immediately treated. Difficulty in talking (small tidal volumes due to phrenic block) and drowsiness are signs that the block is becoming excessively high and should be managed as an emergency - see total spinal.

Local anaesthetic toxicity can also occur as a result of an excessive dose of local anaesthetic in the epidural space. Even a moderate dose of local anaesthetic,

when injected directly into a blood vessel, can cause toxicity. This is especially possible when an epidural catheter is inadvertently advanced into one of the many epidural veins. It is therefore vital to aspirate from the epidural catheter prior to injecting local anaesthetic. Symptoms usually follow a sequence of light-headedness, tinnitus, circumoral tingling or numbness and a feeling of anxiety or “impending doom”, followed by confusion, tremor, convulsions, coma and cardio-respiratory arrest. It is important to recognise these symptoms early, and discontinue the further administration of local anaesthetic drugs. Treatment should be supportive, with the use of sedative/anticonvulsants (thiopentone, diazepam) where necessary, and cardiopulmonary resuscitation if required.

Total spinal is a rare complication occurring when the epidural needle, or epidural catheter, is advanced into the subarachnoid space without the operator’s knowledge, and an “epidural dose” e.g. 10-20 ml of local anaesthetic is injected directly into the CSF. The result is profound hypotension, apnoea, unconsciousness and dilated pupils as a result of the action of local anaesthetic on the brainstem. The use of a test dose should prevent most cases of total spinal, but cases have been described where the epidural initially appeared to be correctly sited, but subsequent top-up doses caused the symptoms of total spinal. This has been ascribed to migration of the epidural catheter into the subarachnoid space, although the precise mechanism is uncertain.

Management of total spinal

- Airway - secure airway and administer 100% oxygen
- Breathing - ventilate by facemask and intubate.
- Circulation - treat with i/v fluids and vasopressor e.g. ephedrine 3-6mg or metaraminol 2mg increments or 0.5-1ml adrenaline 1:10 000 as required
- Continue to ventilate until the block wears off (2 - 4 hours)
- As the block recedes the patient will begin recovering consciousness followed by breathing and then movement of the arms and finally legs. Consider some sedation (diazepam 5 - 10mg i/v) when the patient begins to recover consciousness but is still intubated and requiring ventilation.

Accidental dural puncture is usually easily recognised by the immediate loss of CSF through the epidural needle. This complication occurs in 1-2% of epidural blocks, although it is more common in inexperienced hands. It leads to a high incidence of post dural puncture headache, which is severe and associated with a number of characteristic features. The headache is typically frontal, exacerbated by movement or sitting upright, associated with photophobia, nausea and vomiting, and relieved when lying flat. Young patients, especially obstetric patients, are more susceptible than the elderly. The headache is thought to be due to the leakage of CSF through the puncture site. Basic measures, such as simple analgesics, caffeine, bed rest, fluid rehydration and reassurance are indicated in the first instance, and are often sufficient to treat the headache. Where the headache is severe, or unresponsive to conservative measures, an epidural blood patch may be used to treat the headache. This procedure is effective in treating approximately 90% of post dural puncture headaches. If unsuccessful, the blood patch may be repeated, and the success rate increases to 96% on the second attempt. The blood injected into the epidural space is thought to seal the hole in the dura.

Procedure for epidural blood patch

Indications

- Clinical diagnosis of post dural puncture headache.
- Sufficiently severe so as to be incapacitating.
- Unrelieved by 2-3 days of conservative management

Contraindications

- Unexplained neurological symptoms
- Active neurological disease
- Localised sepsis in lumbar area
- Generalised sepsis
- Coagulopathy

Technique

- Obtain informed consent following full explanation of technique, potential hazards and anticipated success rate
- Move patient to fully equipped work area
- Two operators required, both taking full sterile precautions (gloves, gown, mask)

- Position patient in lateral position or sitting
- Operator 1: sterilise skin over back, drape and perform epidural puncture at the same level as previous puncture or one level below
- Operator 2: simultaneously sterilise skin over antecubital fossa, drape and perform venepuncture withdrawing 20ml of blood.
- Blood is handed to operator 1 who injects blood via epidural needle until either the patient complains of a tightness in the buttocks or lower back, or until 20ml is injected
- Inject remaining blood into blood culture bottles for culture and sensitivity
- Nurse patient supine for 1 hour followed by careful mobilisation.

Epidural haematoma is a rare but potentially catastrophic complication of epidural anaesthesia. The epidural space is filled with a rich network of venous plexuses, and puncture of these veins, with bleeding into the confined epidural space, may lead to the rapid development of a haematoma which may lead to compression of the spinal cord, and can have disastrous consequences for the patient including paraplegia. For this reason, coagulopathy or therapeutic anticoagulation with heparin or oral anticoagulants has long been an absolute contraindication to epidural blockade.

Infection is another rare but potentially serious complication. Pathogenic organisms can be introduced into the epidural space if strict asepsis is not observed during the performance of the block. The commonest pathogens are *Staphylococcus aureus* and streptococci. Meningitis has been described, as has epidural abscess. In addition to the symptoms of spinal cord compression described above, the patient may exhibit signs of infection such as pyrexia and a raised white cell count. Once again, a high index of suspicion is needed, and surgical decompression of an abscess should be performed without delay.

Failure of block can occur as a result of many factors, the most important being the experience of the operator. False loss of resistance during performance of the block may lead to insertion of the epidural catheter into an area other than the epidural space, with

failure to establish anaesthesia. Segmental sparing occurs occasionally for reasons that are unclear, but are assumed to be the result of anatomic variation of the epidural space, so that local anaesthetic fails to spread evenly throughout the space. The result is that some nerve roots are inadequately soaked with local anaesthetic, leaving the dermatomes of these nerve roots poorly anaesthetised. Unilateral blockade occurs occasionally, and this is thought to be the result of a septated epidural space, with failure of the local anaesthetic solution to spread to one half of the epidural space. Positioning the patient on his side with the unblocked side down is sometimes successful in allowing spread of the local anaesthetic to the dependent side, giving bilateral anaesthesia.

Further reading:

- [1] Sharrock NE, Haas SB, Hargett MJ et al. Effects of epidural analgesia on the incidence of deep vein thrombosis after total knee arthroplasty. *Journal of Bone and Joint Surgery American Volume* 1991;73:502-6.
- [2] Dalldorf PG, Perkins FM, Totterman S, Pellegrini VD. Deep venous thrombosis following total hip arthroplasty. Effects of prolonged postoperative epidural analgesia. *Journal of Arthroplasty* 1994;9:611-6.
- [3] Perler BA, Christopherson R, Rosenfeld BA et al. The influence of anaesthetic method on infrainguinal bypass graft patency: a closer look. *American Journal of Surgery* 1995;61:784-9.
- [4] Bach S, Noreng MF, Tjellden NU. Phantom limb pain in amputees during the first 12 months following limb amputation, after preoperative lumbar epidural blockade. *Pain* 1988;33:297-301.
- [5] Yeager MP, Glass DD, Neff RK, Brinck-Johnsen T. Epidural anaesthesia and analgesia in high-risk surgical patients. *Anesthesiology* 1987;66:729-36.
- [6] Bromage PR. Continuous Epidural Analgesia. In "Epidural Analgesia" Bromage PR (ed) W.B. Saunders 1978 p. 237-8.
- [7] Mulroy MF. Epidural opioid delivery methods: bolus, continuous infusion, and patient-controlled epidural analgesia. *Regional Anaesthesia* 1996;21:100-4.
- [8] Ngan Kee WD. Epidural pethidine: pharmacology and clinical experience. *Anaesthesia and Intensive Care* 1998;26:247-55.
- [9] Horlocker TT, Wedel DJ. Spinal and epidural blockade and perioperative low molecular weight heparin: smooth sailing on the Titanic (editorial). *Anesthesia and Analgesia* 1998;86:1153-6.
- [10] Rodgers A, Walker N, Schug S et al. Reduction of postoperative mortality and morbidity with epidural or spinal anaesthesia: results from overview of randomised trials. *British Medical Journal* 2000;321:1493-7

ACID BASE BALANCE

Dr Stephen Drage & Dr Douglas Wilkinson, Oxford, England

Key to terms used

Nanomol (nmol)	$1 \times 10^{-9} \text{ mol} = 0.000000001 \text{ mol}$
Ion	Electrically charged particle formed when molecules are in solution
Enzyme	An organic substance which accelerates reactions
Reduced state	Some substances can combine reversibly with O_2 - the reduced state is when it is not combined with O_2
Aerobic metabolism	Metabolic process using oxygen from the air
Anaerobic metabolism	Metabolic process without oxygen - often less efficient and used for short periods

Introduction

The aim of this article is to provide the reader with a basic understanding of the physiology and biochemistry of acid base balance and its disturbances. This subject is often made unnecessarily complex and most disturbances of acid base control can be understood with the application of a few key principles.

The Hydrogen Ion and pH

The hydrogen ion consists of a single positively charged particle (the proton) that is not orbited by any electrons. The hydrogen ion is, therefore, the smallest ionic particle and is extremely reactive. It is this fact that accounts for its profound effect on the functioning of biological systems at very low concentrations.

In the environment hydrogen ion concentrations vary over an enormous scale (from less than 10^{-14} mol/l to more than 1 mol/l).

The pH scale was developed in order to simplify (or perhaps further complicate!) the mathematics of handling such a large range of numbers. The pH is calculated by taking the negative logarithm of the hydrogen ion concentration, as shown below.

$$\text{pH} = -\log_{10}[\text{H}^+]$$

where $[\text{H}^+]$ is the hydrogen ion concentration.

Logarithms and pH: Worked Example

$$[\text{H}^+] = 0.0000001 \text{ mol/l} = 10^{-7} \text{ mol/l}$$



$$\log_{10}[\text{H}^+] = -7$$



$$-\log_{10}[\text{H}^+] = 7$$



$$\text{pH} = 7$$

Fig 1

Figure 1 gives an example of how pH is calculated.

Table 1 gives examples of pH values and corresponding hydrogen ion concentrations. It is important to note that an increase of one pH point results in a ten-fold decrease in hydrogen ion concentration.

Table 1: pH and Hydrogen ion concentration

pH	[H ⁺] nanomol/l
6.0	1000
7.0	100
8.0	10
9.0	1

Teaching point

As a solution becomes more acidic or less alkaline, the pH falls (hydrogen ion concentration rises). The opposite happens when solutions become less acidic or more alkaline

Although pH terminology is widely used in textbooks and in biochemistry reports, it is important to realise that pH is merely a reflection of the hydrogen ion concentration. In the rest of this article both terms will be used to impress upon the reader that, essentially, they refer to the same thing.

Acids, Bases and Buffers

Acids: An acid is defined as any compound, which forms hydrogen ions in solution. For this reason acids are sometimes referred to as “proton donors”. To aid understanding of these concepts consider an imaginary acid with the chemical formula HA. In the first example in Figure 2, the acid dissociates (separates) into hydrogen ions and the conjugate base when in solution.

Bases: A base is a compound that combines with hydrogen ions in solution. Therefore, bases can be referred to as “proton acceptors”.

Strong Acids: A strong acid is a compound that ionizes completely in solution to form hydrogen ions and a base. Example 2 illustrates a strong acid in solution, where this dissociation is complete.

Weak Acids and Bases: these are compounds that are only partially ionised in solution. Example 3 shows a weak acid in solution with incomplete dissociation.

Buffers: A buffer is a compound that limits the change in hydrogen ion concentration (and so pH) when hydrogen ions are added or removed from the solution. It may be useful to think of the buffer as being like a

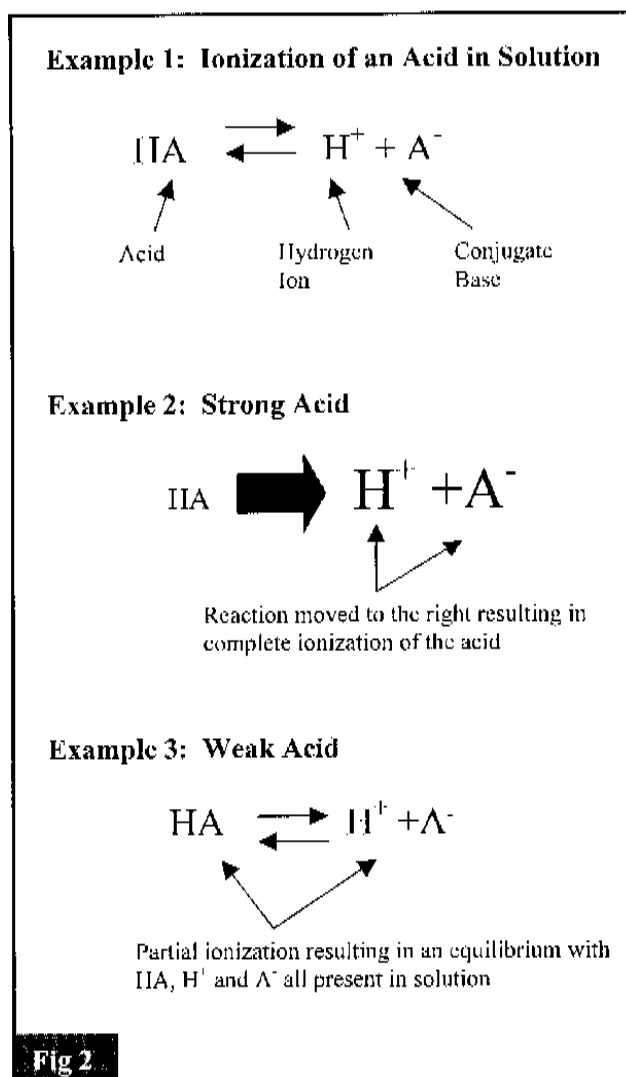

sponge. When hydrogen ions are in excess, the sponge mops up the extra ions. When in short supply the sponge can be squeezed out to release more hydrogen ions!

All buffers are in fact weak acids or bases. Figure 3 shows how as hydrogen ions are added to a buffer solution they combine with A⁻ (the conjugate base) and the reaction is pushed to the left. This creates more HA whilst removing the excess H⁺ from the solution. Similarly, as hydrogen ions are removed from solution by addition of a strong base the reaction moves to the right restoring the hydrogen ion concentration and reducing the quantity of HA.

The effects of buffers can also be illustrated graphically. If a strong acid is added slowly to a buffer solution and the hydrogen ion concentration [H⁺] is measured then a plot similar to the one in figure 4 will be generated. Notice that during the highlighted

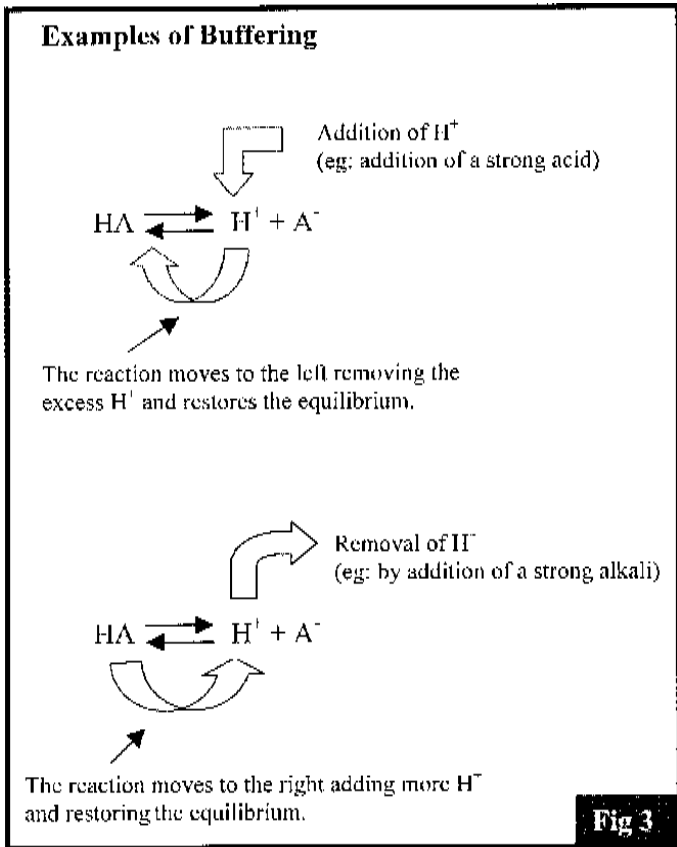

a change in pH will alter the degree ionization of a protein, which may in turn affect its functioning. At more extreme hydrogen ion concentrations a protein's structure may be completely disrupted (the protein is then said to be denatured).

Enzymes function optimally over a very narrow range of hydrogen ion concentrations. For most enzymes this optimum pH is close to the physiological range for plasma (pH= 7.35 to 7.45, or $[H^+]= 35$ to 45nmol/l). Figure 5 shows a typical graph obtained when enzyme activity is plotted against pH. Notice that the curve is a narrow bell shape centred around physiological pH.

Although most enzymes function optimally around physiological pH it should be noted that a few enzymes function best at a much higher hydrogen ion concentration (ie: at a lower pH). The most notable of these enzymes is pepsin, which works best in the acid environment of the stomach - optimum pH 1.5-3 or $[H^+]= 3\text{-}30$ million nanomol/l .

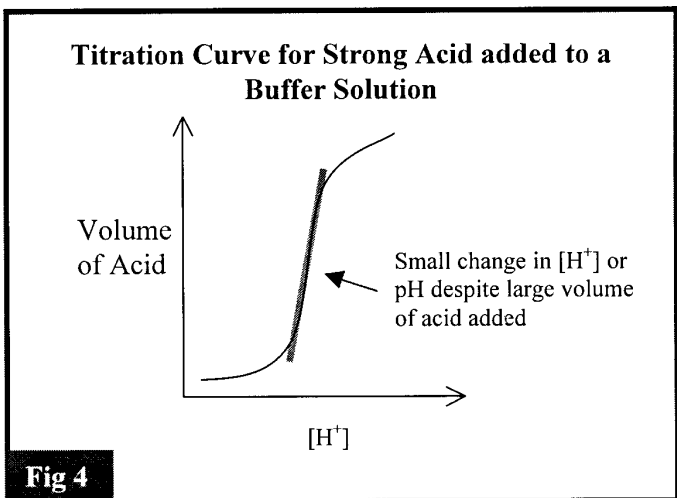

portion of the curve a large volume of acid is added with little change in $[H^+]$ or pH.

As we shall see later buffers are crucial in maintaining hydrogen ions within a narrow range concentrations in the body.

The Importance of Hydrogen Ion Concentration

Hydrogen ion concentration has a widespread effect on the function of the body's enzyme systems. The hydrogen ion is highly reactive and will combine with bases or negatively charged ions at very low concentrations. Proteins contain many negatively charged and basic groups within their structure. Thus,

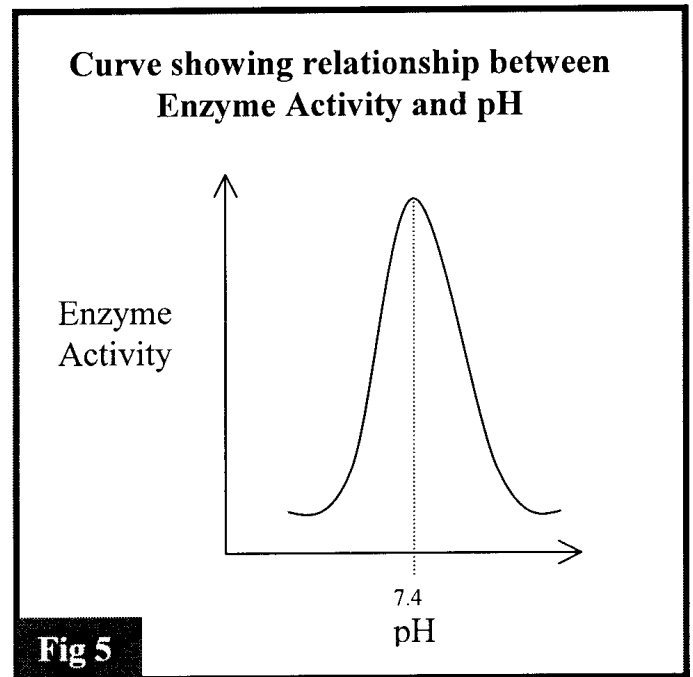

As enzymes have a huge number of functions around the body, an abnormal pH can result in disturbances in a wide range of body systems. Thus, disturbances in pH may result in abnormal respiratory and cardiac function, derangements in blood clotting and drug metabolism, to name but a few. From these few examples it is clear that the anaesthetist should strive to ensure that hydrogen ion concentration is maintained within the normal range.

Production of Hydrogen Ions

The processes of metabolism generate hydrogen ions. Small amounts (40-80mmol/24h) are formed from the oxidation of amino acids and the anaerobic metabolism of glucose to lactic and pyruvic acid. Far more acid is produced as a result of carbon dioxide (CO₂) release from oxidative (aerobic) metabolism - 15,000mmol/24h (15x10³ mmol/24h). Although CO₂ does not contain hydrogen ions it rapidly reacts with water to form carbonic acid (H₂CO₃), which further dissociates into hydrogen and bicarbonate ions (HCO₃⁻). This reaction is shown below:



This reaction occurs throughout the body and in certain circumstances is speeded up by the enzyme carbonic anhydrase. Carbonic acid is a weak acid and with bicarbonate, its conjugate base, forms the most important buffering system in the body.

Acids or bases may also be ingested, however, it is uncommon for these to make a significant contribution to the body's hydrogen ion concentration, other than in deliberate overdose.

Control of Hydrogen Ion Concentration

With hydrogen ion concentration being so critical to enzyme function, the body has sophisticated mechanisms for ensuring pH remains in the normal range. Three systems are involved: blood and tissue buffering, excretion of CO₂ by the lungs and the renal excretion of H⁺ and regeneration of HCO₃⁻.

1. Buffers

As we have seen, buffers are able to limit changes in hydrogen ion concentration. This prevents the large quantities of hydrogen ions produced by metabolism resulting in dangerous changes in blood or tissue pH.

a) Bicarbonate

This is the most important buffer system in the body. Although bicarbonate is not an efficient buffer at physiological pH its efficiency is improved because CO₂ is removed by the lungs and bicarbonate regenerated by the kidney. There are other buffers that act in a similar way to bicarbonate, for example: hydrogen phosphate (HPO₃²⁻), however, these are present in smaller concentrations in tissues and plasma.

b) Proteins

As mentioned earlier many proteins, and notably albumin, contain weak acidic and basic groups within their structure. Therefore, plasma and other proteins form important buffering systems. Intracellular proteins limit pH changes within cells, whilst the protein matrix of bone can buffer large amounts of hydrogen ions in patients with chronic acidosis.

c) Haemoglobin

Haemoglobin (Hb) is not only important in the carriage of oxygen to the tissues but also in the transport of CO₂ and in buffering hydrogen ions (*The physiology of oxygen delivery, Update in anaesthesia 1999; 10:8-14*).

Haemoglobin binds both CO₂ and H⁺ and so is a powerful buffer. Deoxygenated haemoglobin has the strongest affinity for both CO₂ and H⁺; thus, its buffering effect is strongest in the tissues. Little CO₂ is produced in red cells and so the CO₂ produced by the tissues passes easily into the cell down a concentration gradient. Carbon dioxide then either combines directly with haemoglobin or combines with water to form carbonic acid. The CO₂ that binds directly with haemoglobin combines reversibly with terminal amine groups on the haemoglobin molecule to form carbaminohaemoglobin. In the lungs the CO₂ is released and passes down its concentration gradient into the alveoli.

The buffering of hydrogen ions formed from carbonic acid is more complicated. The chain of events that occurs within the red cell is most easily understood by referring to figure 6.

In the tissues, dissolved CO₂ passes into the red blood cell down its concentration gradient where it combines with water to form carbonic acid. This reaction is catalysed by the enzyme carbonic anhydrase. Carbonic acid then dissociates into bicarbonate and hydrogen ions. The hydrogen ions bind to reduced haemoglobin to form HHb. Bicarbonate ions (HCO₃⁻) generated by this process pass back into the plasma in exchange for chloride ions (Cl⁻). This ensures that there is no net loss or gain of negative ions by the red cell. In the lungs this process is reversed and hydrogen ions bound to haemoglobin recombine with bicarbonate to form CO₂ which passes into the alveoli. In addition, reduced Hb is reformed to return to the tissues.

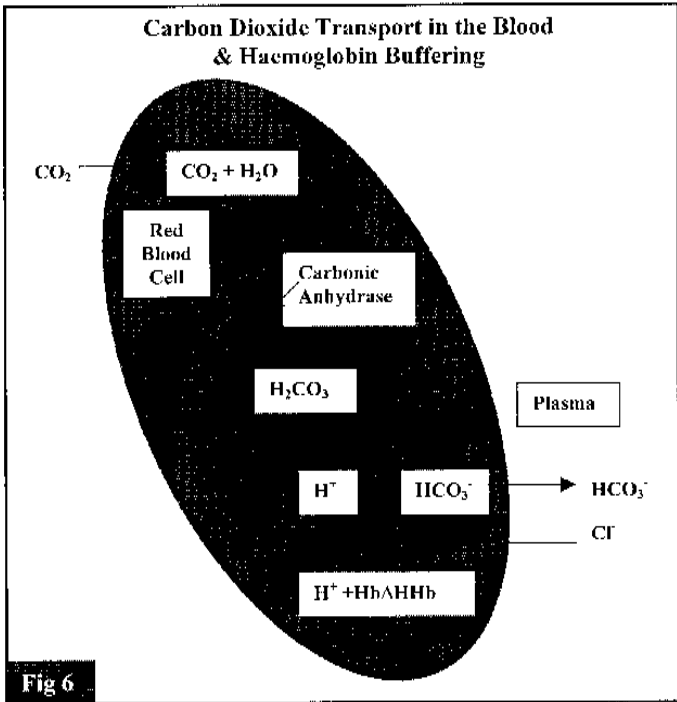

Fig 6

2. Carbon Dioxide Elimination

As mentioned earlier CO_2 is responsible for the majority of hydrogen ions produced by metabolism. Therefore, the respiratory system forms the single most important organ system involved in the control of hydrogen ions. From respiratory physiology it should be remembered that the arterial partial pressure of CO_2 (PaCO_2) is inversely proportional to alveolar ventilation (ie: if alveolar ventilation falls the PaCO_2 rises). Therefore, relatively small changes in ventilation can have a profound effect on hydrogen ion concentration and pH. An acute rise in PCO_2 of 1Kilopascal (kPa) results in a 5.5nmol/l rise in the hydrogen ion concentration (resulting in a fall in plasma pH from 7.4 to 7.34).

The importance of PaCO_2 and hydrogen ion concentration is underlined by the fact that the control of ventilation is brought about by the effect of CO_2 on cerebrospinal fluid (CSF) pH. The detail of the control of breathing and elimination of CO_2 are beyond the remit of article but have been discussed in a previous issue of update (Update in anaesthesia 1999; 10:8-14)

3. Renal Handling of Bicarbonate and Hydrogen Ions

The kidneys not only secrete hydrogen ions but they also regenerate bicarbonate ions. The renal handling of electrolytes also influences acid base balance. All

aspects of renal involvement in acid base balance are interlinked, but for clarity are dealt with separately below.

a) Regeneration of Bicarbonate:

Bicarbonate ions are freely filtered by the glomerulus. The concentration of bicarbonate in the tubular fluid is equivalent to that of plasma. If bicarbonate were not reabsorbed the buffering capacity of the blood would rapidly be depleted.

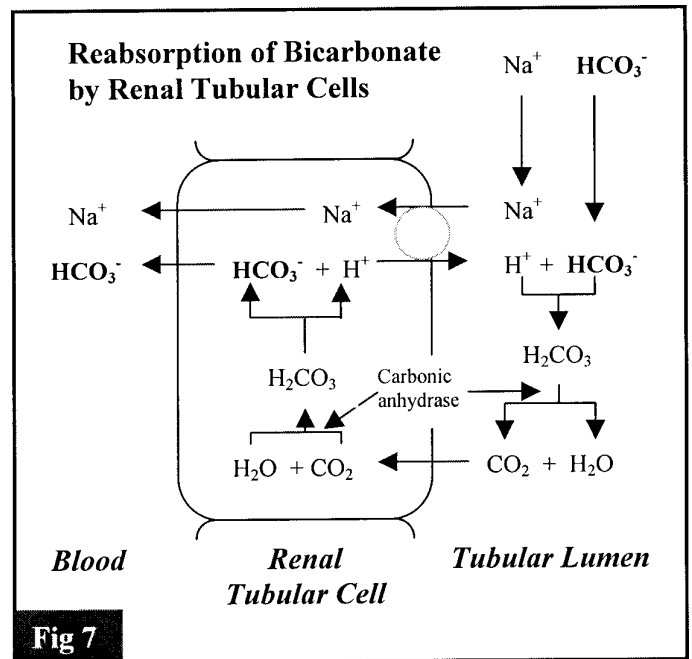

Fig 7

The process of reabsorption of bicarbonate occurs mostly in the proximal convoluted tubule and is summarised in figure 7.

Filtered bicarbonate combines with secreted hydrogen ions forming carbonic acid. Carbonic acid then dissociates to form CO_2 and water. This reaction is catalysed by carbonic anhydrase, which is present in the brush border of the renal tubular cells. This CO_2 readily crosses into the tubular cell down a concentration gradient.

Inside the cell the CO_2 recombines with water, again under the influence of carbonic anhydrase, to form carbonic acid. The carbonic acid further dissociates to bicarbonate and hydrogen ions. The bicarbonate passes back into the blood stream whilst the H^+ passes back into the tubular fluid in exchange for sodium. In this way, virtually all the filtered bicarbonate is reabsorbed in the healthy individual.

b) Excretion of Hydrogen Ions

Hydrogen ions are actively secreted in the proximal and distal tubules, but the maximum urinary $[H^+]$ is around 0.025mmol/l (pH 4.6). Therefore, in order to excrete the $30\text{--}40\text{mmol}$ of H^+ required per day, a urine volume of 1200 litres would have to be produced. However, buffering of hydrogen ions also occurs in the urine. This allows the excretion of these large quantities of H^+ without requiring such huge urine volumes. Hydrogen ion secretion occurs against a steep concentration gradient, 40nmol/l in plasma against up to 25000nmol/l ($25 \times 10^3\text{nmol/l}$) in urine. Therefore, hydrogen ion secretion is an active process and requires energy in the form of ATP.

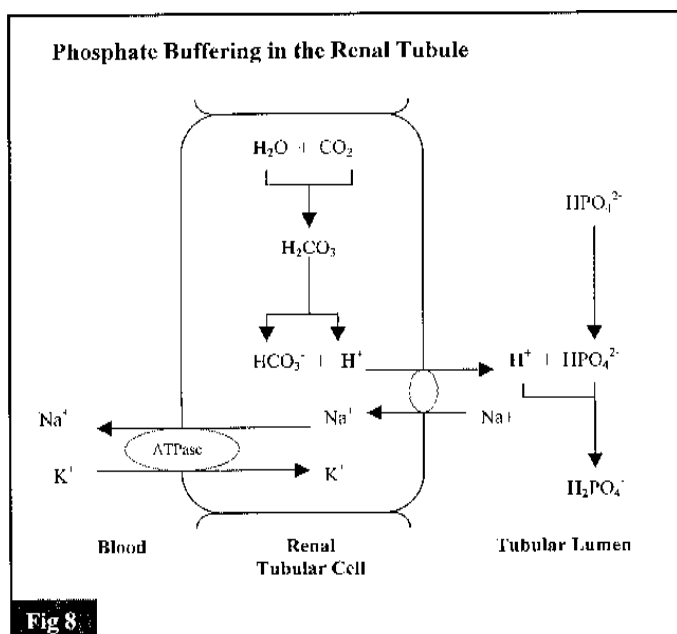

The predominant buffers in the urine are phosphate (HPO_4^{2-}) and ammonia (NH_3). Phosphate is freely filtered by the glomerulus and passes down the tubule where it combines with H^+ to form H_2PO_4^- . Hydrogen ions are secreted in exchange for sodium ions; the energy for this exchange comes from the sodium-potassium ATPase that maintains the concentration gradient for sodium. These events are summarised in figure 8.

Ammonia is produced in renal tubular cells by the action of the enzyme glutaminase on the amino acid glutamine. This enzyme functions optimally at a lower (more acidic) than normal pH. Therefore, more

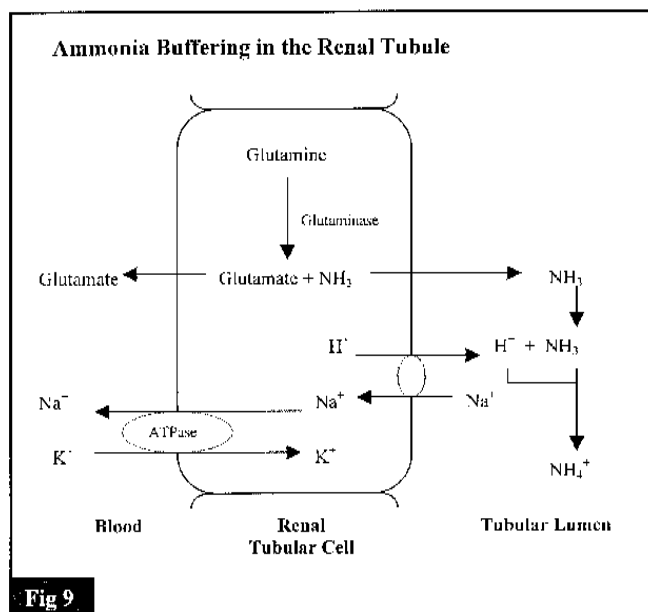

ammonia is produced during acidosis improving the buffering capacity of the urine. Ammonia is unionised and so rapidly crosses into the renal tubule down its concentration gradient. The ammonia combines with H^+ to form the ammonium ion, which being ionised does not pass back into the tubular cell. The ammonium ion is therefore lost in the urine, along with the hydrogen ion it contains. See figure 9 below.

c) Electrolytes

Sodium/Potassium: sodium reabsorption and hydrogen ion excretion are interlinked. Sodium reabsorption is controlled by the action of aldosterone on ion exchange proteins in the distal tubule. These ion exchange proteins exchange sodium for hydrogen or potassium ions. Thus, changes in aldosterone secretion may result in altered acid secretion.

Chloride: The number of positive and negative ions in the plasma must balance at all times. Aside from the plasma proteins, bicarbonate and chloride are the two most abundant negative ions (anions) in the plasma. In order to maintain electrical neutrality any change in chloride must be accompanied by the opposite change in bicarbonate concentration. Therefore, the chloride concentration may influence acid base balance.

Disorders of Hydrogen Ion Homeostasis

Disturbance of the body's acid base balance results in the plasma containing either too many hydrogen ions

(acidaemia) or too few hydrogen ions (alkalaemia). In other words, the pH is too low in acidaemia (less than 7.35) whilst in alkalaemia the pH is too high (more than 7.45). These disturbances may be due to respiratory causes (ie: changes in PaCO₂) or non-respiratory (metabolic) causes. When the cause of the acid base disturbance has been discovered, the words acidosis or alkalosis may be used in conjunction with the physiological cause of the disturbance (ie: respiratory acidosis, metabolic alkalosis etc). These are discussed in more detail below.

Respiratory Acidosis

This results when the PaCO₂ is above the upper limit of normal, >6kPa (45mmHg). The relationship between hydrogen ion concentration and CO₂ was discussed earlier (Production of Hydrogen Ions). Respiratory acidosis is most commonly due to decreased alveolar ventilation causing decreased excretion of CO₂. Less commonly it is due to excessive production of CO₂ by aerobic metabolism.

a) Inadequate CO₂ Excretion: the causes of decreased alveolar ventilation are numerous, they are summarised in Fig 10. Many of the

causes of decreased alveolar ventilation are of interest to the anaesthetist and many are under our control.

b) Excess CO₂ Production: respiratory acidosis is rarely caused by excess production of CO₂. This may occur in syndromes such as malignant hyperpyrexia, though a metabolic acidosis usually predominates. More commonly, modest overproduction of CO₂ in the face of moderately depressed ventilation may result in acidosis. For example, in patients with severe lung disease a pyrexia or high carbohydrate diet may result in respiratory acidosis.

Respiratory Alkalosis

Results from the excessive excretion of CO₂, and occurs when the PaCO₂ is less than 4.5kPa (34mmHg). This is commonly seen in hyperventilation due to anxiety states. In more serious disease states, such as severe asthma or moderate pulmonary embolism, respiratory alkalosis may occur. Here hypoxia, due to ventilation perfusion (V/Q) abnormalities, causes hyperventilation (in the spontaneously breathing patient). As V/Q abnormalities have little effect on the

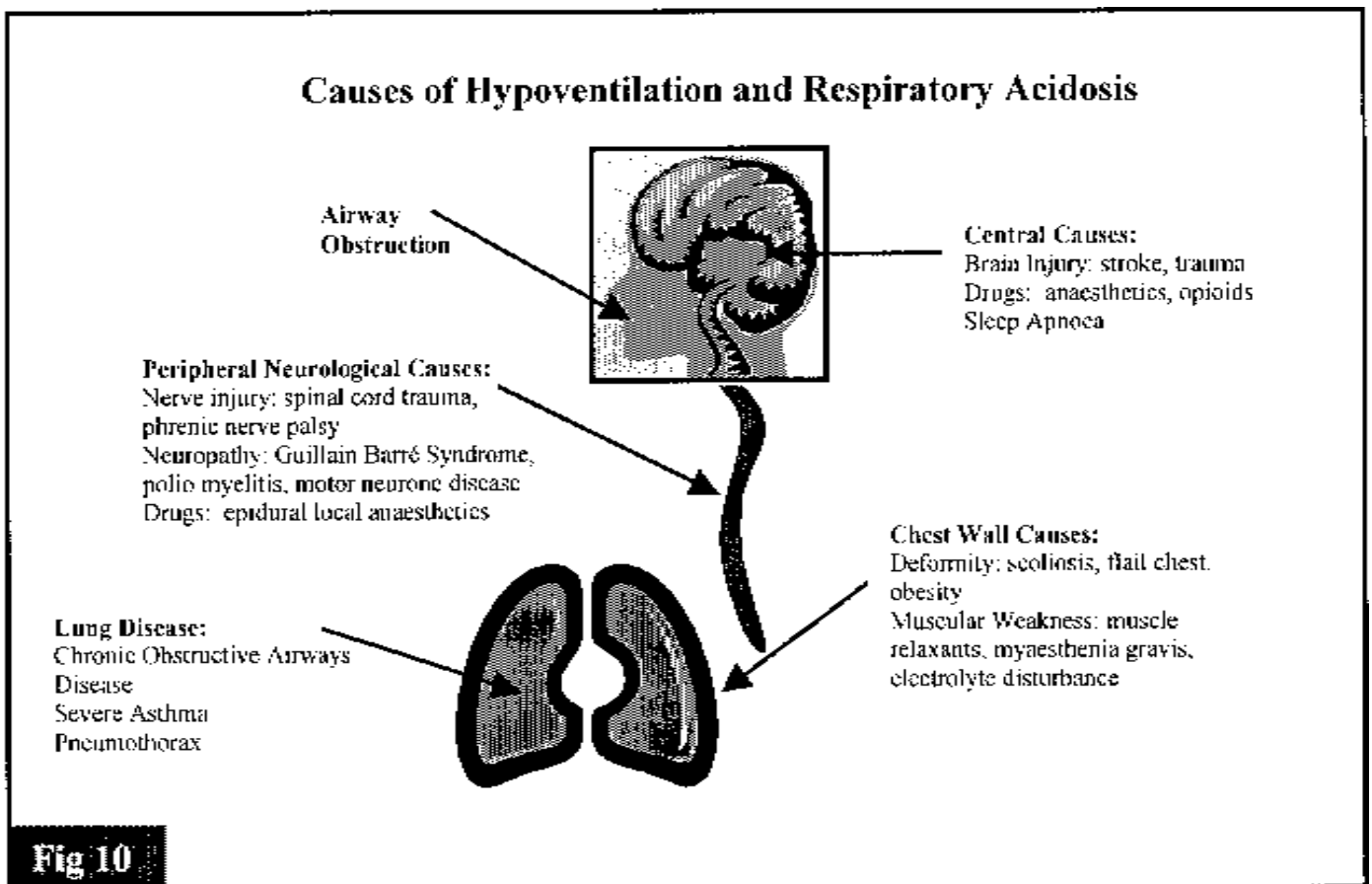

excretion of CO_2 the patients tend to have a low arterial partial pressure of oxygen (PaO_2) and low PaCO_2 .

Metabolic Acidosis

May result from either an excess of acid or reduced buffering capacity due to a low concentration of bicarbonate. Excess acid may occur due increased production of organic acids or, more rarely, ingestion of acidic compounds.

a) Excess H^+ Production: this is perhaps the commonest cause of metabolic acidosis and results from the excessive production of organic acids (usually lactic or pyruvic acid) as a result of anaerobic metabolism. This may result from local or global tissue hypoxia. Tissue hypoxia may occur in the following situations:

- Reduced arterial oxygen content: for example anaemia or reduced PaO_2 .
- Hypoperfusion: this may be local or global. Any cause of reduced cardiac output may result in metabolic acidosis (eg: hypovolaemia, cardiogenic shock etc). Similarly, local hypoperfusion in conditions such as ischaemic bowel or an ischaemic limb may cause acidosis.
- Reduced ability to use oxygen as a substrate. In conditions such as severe sepsis and cyanide poisoning anaerobic metabolism occurs as a result of mitochondrial dysfunction.

Another form of metabolic acidosis is diabetic ketoacidosis. Cells are unable to use glucose to produce energy due to the lack of insulin. Fats form the major source of energy and result in the production of ketone bodies (aceto- acetate and 3-hydroxybutyrate) from acetyl coenzyme A. Hydrogen ions are released during the production of ketones resulting in the metabolic acidosis often observed.

b) Ingestion of Acids: this is an uncommon cause of metabolic acidosis and is usually the result of poisoning with agents such as ethylene glycol (antifreeze) or ammonium chloride.

c) Inadequate Excretion of H^+ : this results from renal tubular dysfunction and usually occurs in conjunction with inadequate reabsorption of bicarbonate. Any form of renal failure may result in metabolic acidosis. There are also specific disorders of renal

hydrogen ion excretion known as the renal tubular acidoses.

Some endocrine disturbance may also result in inadequate H^+ excretion e.g. hypoaldosteronism. Aldosterone regulates sodium reabsorption in the distal renal tubule. As sodium reabsorption and H^+ excretion are linked, a lack of aldosterone (eg: Addison's disease) tends to result in reduced sodium reabsorption and, therefore, reduced ability to excrete H^+ into the tubule resulting in reduced H^+ loss. The potassium sparing diuretics may have a similar effect as they act as aldosterone antagonists.

d) Excessive Loss of Bicarbonate: gastrointestinal secretions are high in sodium bicarbonate. The loss of small bowel contents or excessive diarrhoea results in the loss of large amounts of bicarbonate resulting in metabolic acidosis. This may be seen in such conditions as Cholera or Crohn's disease.

Acetazolamide, a carbonic anhydrase inhibitor, used in the treatment of acute mountain sickness and glaucoma, may cause excessive urinary bicarbonate losses. Inhibition of carbonic anhydrase slows the conversion of carbonic acid to CO_2 and water in the renal tubule. Thus, more carbonic acid is lost in the urine and bicarbonate is not reabsorbed. The importance of carbonic anhydrase in the reabsorption of bicarbonate was illustrated in Figure 7.

Metabolic Alkalosis

May result from the excessive loss of hydrogen ions, the excessive reabsorption of bicarbonate or the ingestion of alkalis.

a) Excess H^+ loss: gastric secretions contain large quantities of hydrogen ions. Loss of gastric secretions, therefore, results in a metabolic alkalosis. This occurs in prolonged vomiting for example, pyloric stenosis or anorexia nervosa.

b) Excessive Reabsorption of Bicarbonate: as discussed earlier bicarbonate and chloride concentrations are linked. If chloride concentration falls or chloride losses are excessive then bicarbonate will be reabsorbed to maintain electrical neutrality. Chloride may be lost from the gastro-intestinal tract, therefore, in prolonged vomiting it is not only the loss of hydrogen ions that results in the alkalosis but

also chloride losses resulting bicarbonate reabsorption. Chloride losses may also occur in the kidney usually as a result of diuretic drugs. The thiazide and loop diuretics a common cause of a metabolic alkalosis. These drugs cause increased loss of chloride in the urine resulting in excessive bicarbonate reabsorption.

c) Ingestion of Alkalis: alkaline antacids when taken in excess may result in mild metabolic alkalosis. This is an uncommon cause of metabolic alkalosis

Compensation

From earlier in the article it should be clear that the systems controlling acid base balance are interlinked. As explained earlier, maintenance of pH as near normal is vital, therefore dysfunction in one system will result in compensatory changes in the others. The three mechanisms for compensation mentioned earlier occur at different speeds and remain effective for different periods.

- **Rapid chemical buffering:** this occurs almost instantly but buffers are rapidly exhausted, requiring the elimination of hydrogen ions to remain effective.
- **Respiratory compensation:** the respiratory centre in the brainstem responds rapidly to changes in CSF pH. Thus, a change in plasma pH or PaCO₂ results in a change in ventilation within minutes.
- **Renal compensation:** the kidneys respond to disturbances in acid base balance by altering the amount of bicarbonate reabsorbed and hydrogen ions excreted. However, it may take up to 2 days for bicarbonate concentration to reach a new equilibrium.

These compensatory mechanisms are efficient and often return the plasma pH to near normal. However, it is uncommon for complete compensation to occur and over compensation does not occur.

Interpretation of Acid Base Disturbances in Blood Gas Results

Blood gas analysis is available in the vast majority of acute hospitals in the developed world. Increasingly blood gas machines are available for use in developing countries. In order to obtain meaningful results from any test it is important that they are interpreted in the light of the patient's condition. This requires knowledge of the patient's history and examination findings.

The simplest blood gas machines measure the pH, PCO₂ and PO₂ of the sample. More complicated machines will also measure electrolytes and haemoglobin concentration. Most blood gas machines also give a reading for the base excess and/or standard bicarbonate. These values are used to assess the metabolic component of an acid base disturbance and are calculated from the measured values outlined above. They are of particular use when the cause of the acid base disturbance has both metabolic and respiratory components.

- **The Base Excess:** is defined as **the amount of acid (in mmol) required to restore 1 litre of blood to its normal pH, at a PCO₂ of 5.3kPa (40mmHg).** During the calculation any change in pH due to the PCO₂ of the sample is eliminated, therefore, the base excess reflects only the metabolic component of any disturbance of acid base balance. If there is a metabolic alkalosis then acid would have to be added to return the blood pH to normal, therefore, the base excess will be positive. However, if there is a metabolic acidosis, acid would need to be subtracted to return blood pH to normal, therefore, the base excess is negative.
- **The Standard Bicarbonate:** this is similar to the base excess. It is defined as **the calculated bicarbonate concentration of the sample corrected to a PCO₂ of 5.3kPa (40mmHg).** Again abnormal values for the standard bicarbonate are only due the metabolic component of an acid base disturbance. A raised standard bicarbonate concentration indicates a metabolic alkalosis whilst a low value indicates a metabolic acidosis.

The flow chart on the next page indicates how to approach the interpretation of acid base disturbances. First examine the pH; as discussed earlier a high pH indicates alkalaemia, whilst a low pH acidaemia. Next look at the PCO₂ and decide whether it accounts for the change in pH. If the PCO₂ does account for the pH then the disturbance is a primary respiratory acid base disturbance. Now look at the base excess (or standard bicarbonate) to assess any metabolic component of the disturbance. Finally, one needs to decide if any compensation for the acid base disturbance has happened. Compensation has occurred if there is a change in the PCO₂ or base excess in the opposite direction from that which would be expected from the pH. For example in respiratory compensation for a metabolic acidosis the PCO₂ will be low. A low

PCO₂ alone causes an alkalaemia (high pH). The body is therefore using this mechanism to try to bring the low pH caused by the metabolic acidosis back towards normal.

By now the complexity of acid base disturbance should be clear!! As in many complex concepts examples may clarify matters. In the following examples work through the flow charts to interpret the data.

Example 1: A 70 year old man is admitted to the intensive car unit with acute pancreatitis. He is hypotensive, hypoxic and in acute renal failure. He has a respiratory rate of 50 breaths per minute. The following blood gas results are obtained:

pH 7.1
 PCO₂ 3.0kPa (22mmHg)
 BE -21.0mmol

From the flow charts: firstly, he has a severe acidaemia (pH 7.1). The PCO₂ is low, which does not account for the change in pH (a PCO₂ of 3.0 would tend to cause alkalaemia). Therefore, this cannot be a primary respiratory acidosis. The base excess of -21 confirms the diagnosis of a severe metabolic acidosis. The low PCO₂ indicates that there is a degree of respiratory

compensation due to hyperventilation. These results were to be expected given the history.

Example 2: A 6 week old male child is admitted with a few days history of projectile vomiting. The following blood gases are obtained:

pH 7.50
 PCO₂ 6.5kPa (48mmHg)
 BE +11.0mmol

The history points to pyloric stenosis. There is an alkalaemia, which is not explained by the PCO₂. The positive base excess confirms the metabolic alkalosis. The raised PCO₂ indicates that there is some respiratory compensation.

Summary

This article has attempted to provide the reader with a grounding in acid base physiology and its importance in anaesthesia and intensive care. It is also hoped that the reader will be able to apply this knowledge in the interpretation of blood gas results. There is an excellent web page to learn more about blood gas results interpretation:-

<http://www.health.adelaide.edu.au/paed-anes/javaman/Respiratory/AcidBase.html>

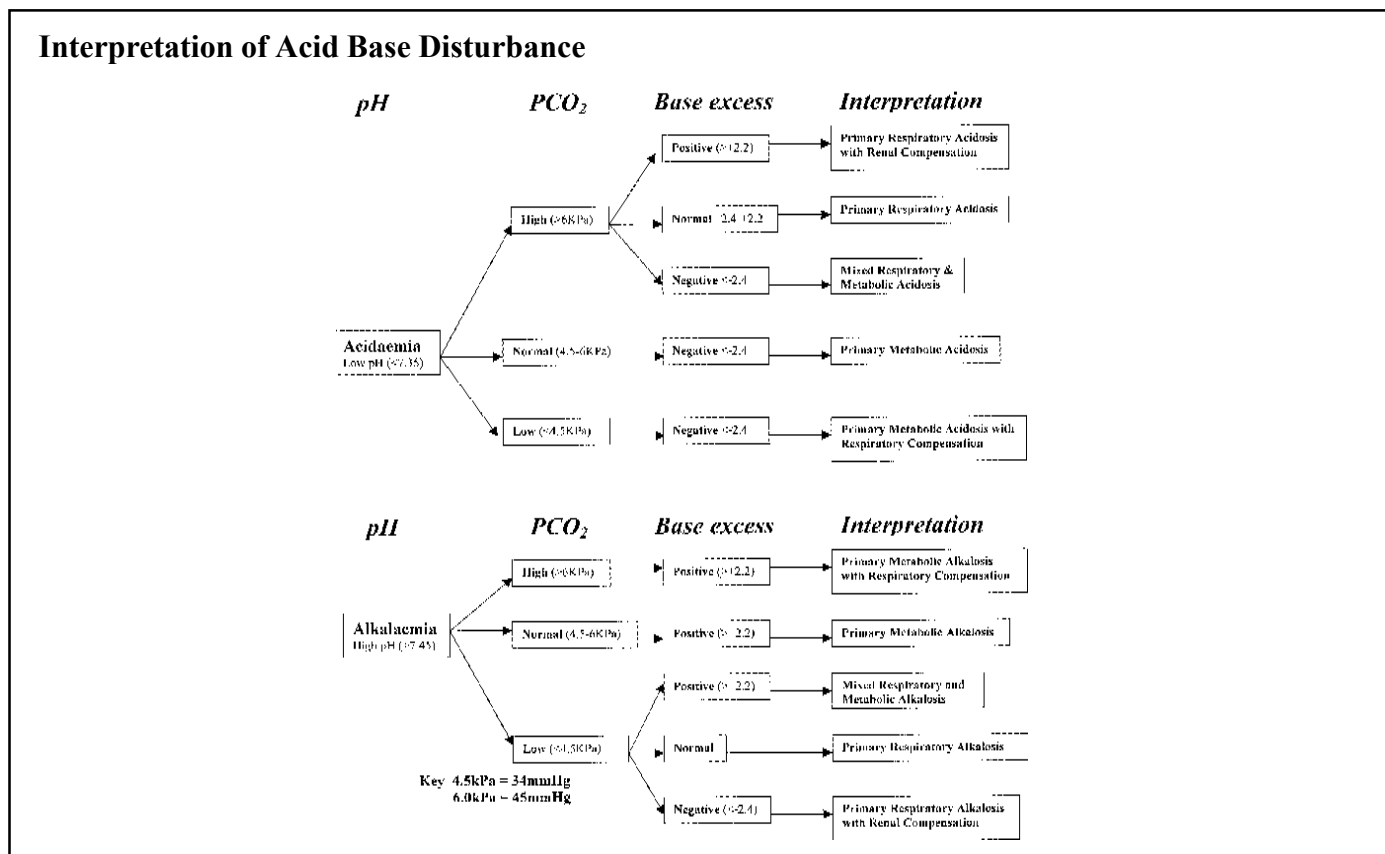

LETTERS TO THE EDITOR

Dear Sir,

When giving 1.5mls (75mg) lignocaine 5% with dextrose for Caesarean section, aiming for a block to T4 dermatome, we have noticed that patients often complain of nasal congestion after the spinal has been given. Patients receiving 2.5mls (12.5mg) bupivacaine 0.5% with dextrose for Caesarean section aiming for the same height of block do not complain of the same symptoms of nasal congestion.

The spinal anaesthetic technique is otherwise exactly the same. A 22 or 25gauge spinal needle is inserted into the L2/3 or 3/4 interspace with the patient sitting. After the spinal needle is removed, the patient lays down flat (we do not often see the supine hypotensive syndrome and so do not routinely use left lateral tilt), 1 - 2 litres crystalloid preload, ephedrine 3-5mg as required for hypotension <100 systolic.

Could you or one of your experts please explain this finding?

Yours sincerely,

Victor Chelewani, Alphonso Nundwe
Clinical Officer Anaesthetists
Queen Elizabeth Central Hospital
Blantyre
Malawi

Nasal congestion occurring during regional anaesthesia for Caesarean section usually indicates an excessively high block, and is caused by blockade of the cervical sympathetic outflow. Most of these patients will also demonstrate unilateral or bilateral Horner's syndrome. I suspect the reason you are seeing it when you use lignocaine but not with bupivacaine is that your dose of the former (1.5 ml) is rather generous. 5% hyperbaric lignocaine is no longer available in the UK where I practice due to concerns about neurotoxicity, but when it was in use, 1.0 - 1.2 ml given as you describe would produce a rapid and reproducible block to T4. I suspect that, if you tested your patients, you would find sensory levels in the region of C7-T1.

A couple of other thoughts spring to mind. You may not think you are seeing supine hypotension but, even if the mother's blood pressure does not fall, the fetus will still be compromised by aortic compression diminishing placental blood flow; 15 degrees of left lateral tilt is easily achieved and has been proven to be beneficial. It is worthwhile testing all blocks before Caesarean section; current thinking suggests that we should aim for a block to fine touch to T5 bilaterally to minimise the risk of intra-operative pain.

David Bogod
Consultant Obstetric Anaesthetist
Nottingham City Hospital
UK

Dear Reader

If you would like to receive **Update in Anaesthesia** please write to: Dr C Collins, Secretary, World Anaesthesia, Royal Devon and Exeter Hospital (Wonford), Exeter EX2 5DW, UK. The fax number is +44 1392 402472. Alternatively contact the editor by email ian.wilson5@virgin.net When writing please include

your name, address, email (if available), your title and role, and a few details about your hospital and work. If you would like extra copies of Update to distribute to other anaesthetists, please let us know how many you require, and the names of the readers.

BOOK REVIEW - Dr Bill Casey**Save Lives, Save Limbs**

Hans Husum, Mads Gilbert, Torben Wisborg

ISBN 983-9747-42-8

Price: US \$40 (North), US \$10 (South)

This soft-cover book is written by three Norwegian doctors, two anaesthesiologists and a surgeon, with many years experience working in conflict zones such as Afghanistan, Burma, Cambodia, Kurdistan and Angola. Their particular interest and expertise is in the management of victims of mine injuries. Drawing on their experience, they have written a unique book that is not only aimed at doctors and professional health-care workers but also aims to empower rural communities, the potential victims of mine injuries, to initiate basic and subsequently, sophisticated treatment of the injured.

The book is in six sections. The first combines information on the different types of mines that may be encountered and the injuries they can cause with a tutorial on basic physiology and the body's response to injury. The second section is on basic life support: airway, breathing, circulation and has sections on the management of burns and multiple casualties. In the third section, more advanced life support techniques are illustrated including endotracheal intubation, chest drain insertion, limb fasciotomy and damage control laparotomy. The use of tourniquets is condemned, as is "ideal" but too expensive amputation. The importance of keeping victims warm and orally rehydrating and feeding them is repeatedly stressed.

Subsequent sections contain a series of fascinating case reports illustrating the management of injured patients by their peers with minimal equipment in difficult circumstances and the concepts of the "chain of survival" and the "Village University". The authors develop their thesis that primary trauma management should and must be provided by those most at risk of injury. They describe in detail how villagers can be taught basic and subsequently sophisticated life support techniques. The latter are taught using anaesthetised animals that can subsequently be eaten!

Copious practical advice on suitable drugs, fluid replacement, feeding, surgical techniques and

improvisation is given and reflects the authors' own extensive experience. Examples of charts that can be used to record details of injuries and their management are given and their subsequent use to audit the effectiveness of treatment are given.

The book is comprehensively illustrated with photographs taken in combat zones as well as line drawings and, where appropriate, X-rays. It is well written and easy to read although the use of English is occasionally a little idiosyncratic: inlet and outlet wounds rather than the more usual entry and exit. I was a little surprised to find no mention of the interosseous route of access to the circulation in the section on venous access in children, and that a two rather than four compartment method of lower limb fasciotomy was described. I assume this is a reflection of the authors' practical experience in the field.

I have no reservations about commending this book to all doctors and health-care workers who are involved in teaching or practicing resuscitation either in the developed or the developing world. It is well written, well illustrated, reasonably priced and I am sure everyone will learn much from reading it.

Copies can be obtained from:

Third World Network,
228 Macalister Rd, 10400
Penang, MALAYSIA
Fax: 60 4 2298106 or 60 4 364505
Tel: 60 4 2293511 or 2293713
Email: tw@igc.apc.org
Website: www.twinside.org.sg

or

Tromsø Mine Victim Resource Centre
PO Box 80
N 9038 Ritoe
NORWAY
Tel: 47 776 26227
Fax: 47 776 28073
Email: tmc@rito.no



2nd ALL AFRICA ANAESTHESIA CONGRESS
International Convention Centre
Durban, South Africa
23-26 September 2001

The above meeting is a WFSA African Regional Section Congress and will be held in conjunction with the Annual Meeting of the South African Society of Anaesthesiologists. The meeting will be preceded by a two day refresher course in anaesthesia (22nd & 23rd September 2001)

Contact Details:

SASA 2001/AAAC Congress Secretariat
 Department of Anaesthetics
 Private Bag 7, Congella 4013
 Durban, South Africa
 Tel/Fax: +27 31 260 4472

Email: aaac@nu.ac.za

Website: www.aaac.nu.ac.za



Sponsored by: World Federation of Societies of Anaesthesiologists, Level 8, Imperial House, 15-19 Kingsway, London WC2B 6TH, United Kingdom. Tel: 020 7836 5652. Fax: 020 7836 5616 E-mail: wfsa@compuserve.com

Typeset by: Angela Frost *Printed in Great Britain by:* Media Publishing

Correspondence to editor: Dr I H Wilson, Anaesthetics Dept., Royal Devon & Exeter Healthcare NHS Trust, Barrack Road, Exeter, EX2 5DW, UK. E-mail iain.wilson5@virgin.net

Disclaimer

World Anaesthesia takes all reasonable care to ensure that the information contained in Update is accurate. We cannot be held responsible for any errors or omissions and take no responsibility for the consequences of error or for any loss or damage which may arise from reliance on information contained.